

Lyric[™]

Quick Reference Guide

Model BLMLR



FOR THE LOVE OF SEWING

To register your machine warranty and receive Baby Lock product updates and offers, go to babylock.com/profile. If you have questions with registration, visit your Authorized Baby Lock Retailer.

Baby Lock Consumer Helpline: 800-313-4110

www.babylock.com

Before using your machine for the first time please read the “IMPORTANT SAFETY INSTRUCTIONS” in the Instruction and Reference Guide.

Refer to the instruction and reference guide for detailed instructions.

In this guide, English screens are used for basic explanations.

Antes de utilizar la máquina por primera vez, lea las “INSTRUCCIONES DE SEGURIDAD IMPORTANTES” en la Guía de referencia y de instrucciones.

Consulte las instrucciones detalladas en la guía de referencia y de instrucciones.

En esta guía, para las explicaciones básicas se utilizan pantallas en inglés.

Avant d'utiliser votre machine pour la première fois, veuillez lire les « INSTRUCTIONS DE SÉCURITÉ IMPORTANTES » indiquées dans le guide d'instructions et de référence.

Reportez-vous au guide d'instructions et de référence pour des informations détaillées.

Les écrans de ce guide sont en anglais pour les explications de base.

Contents

Accessories	2
◆ Included Accessories	2
◆ Optional Accessories	2
Bobbin Winding and Setting	6
Upper Threading	8
Name of Machine Parts	10
◆ Operation buttons	10
◆ Operation panel	11
◆ Settings screen	12
Selecting and Sewing Patterns	13
◆ Preset Utility Stitches	13
◆ Utility Stitches	14
◆ Decorative Stitches	15
◆ Character stitches	15
Summary of Stitch Patterns	16
◆ Preset Utility Stitches	16
◆ Utility Stitches	16
◆ Decorative Stitches	16
◆ Character Stitches	17

Contenido

Accesorios	2
◆ Accesorios incluidos	2
◆ Accesorios opcionales	2
Bobinado y ajuste	6
Hilo superior	8
Nombres de las piezas de la máquina	10
◆ Botones de operación	10
◆ Panel de operaciones	11
◆ Pantalla de ajustes	12
Seleccionar y coser patrones	13
◆ Puntadas de utilidad predefinidas	13
◆ Puntadas de utilidad	14
◆ Puntadas decorativas	15
◆ Puntadas de carácter	15
Resumen de tipos de puntada	16
◆ Puntadas de utilidad predefinidas	16
◆ Puntadas de utilidad	16
◆ Puntadas decorativas	16
◆ Puntadas de carácter	17

Table des matières



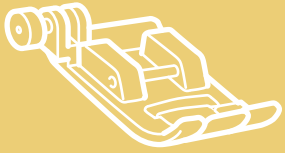







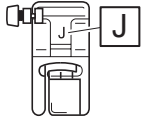
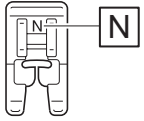
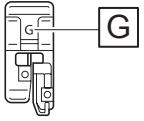
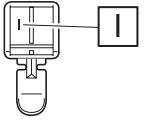
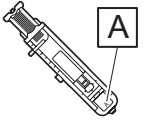
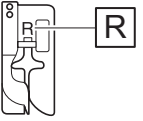
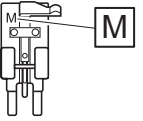
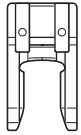

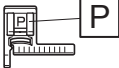
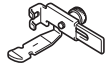
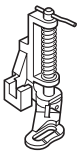
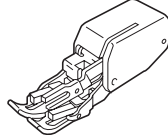
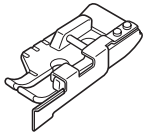



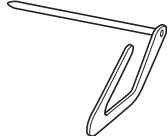



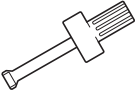
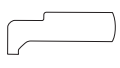





Accessoires	4
◆ Accessoires inclus	4
◆ Accessoires en option	4
Bobinage et réglage de la canette	6
Enfilage supérieur	8
Nom des pièces de la machine	10
◆ Touches de commande	10
◆ Panneau de commande	11
◆ Écran de réglages	12
Sélection et couture de motifs	13
◆ Préréglage des points de couture courants	13
◆ Points de couture courants	14
◆ Points décoratifs	15
◆ Points de caractères	15
Sommaire des motifs de point	16
◆ Préréglage des points de couture courants	16
◆ Points de couture courants	16
◆ Points décoratifs	16
◆ Points de caractères	17



Accessories

Accesorios

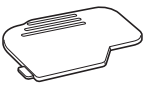
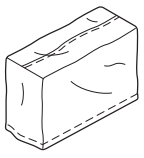

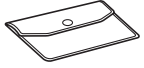
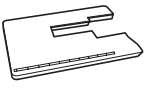



◆ Included Accessories ◆ Accesorios incluidos

1. 	2. 	3. 	4. 	5. 	6. 	7. 
8. 	9. 	10. 	11. 	12. 	13. 	14. 
15.*1 	16.*2 	17. 	18. 	19. 	20. 	21. 
22. 	23. 	24. 	25. 	26. 	27. 	28. 
29. 	30. 	31. 	32. 	33. 	34. 	35. 
36. 	37. 	38. 	39. 	40. 	41. 	41. 

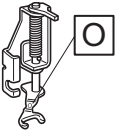
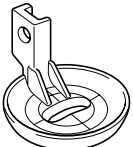
*1 75/11 2 needles, 90/14 2 needles, 90/14 2 needles: Ball point needle (gold colored)
 *2 2.0/11 needle

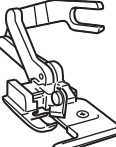
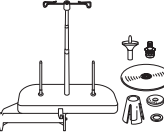
*1 2 agujas 75/11, 2 agujas 90/14, 2 agujas 90/14: aguja de punta redonda (color dorado)
 *2 Aguja 2,0/11

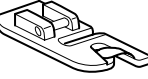
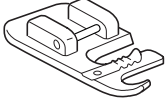
◆ Optional Accessories ◆ Accesorios opcionales

1. 	2. 	3. 	4. 	5. 	6. 	7. 
8. 	9. 	10. 				

◆ Included Accessories

No.	Part Name	Part Code
1	Zigzag foot "J" (on machine)	XF9671-001
2	Monogramming foot "N"	XD0810-031
3	Overcasting foot "G"	XC3098-031
4	Zipper foot "I"	X59370-021
5	Buttonhole foot "A"	XC2691-023
6	Blind stitch foot "R"	XE2650-001
7	Button fitting foot "M"	XE2643-001
8	Open toe foot	FA7
9	Non stick foot	FA8
10	Stitch guide foot "P"	FA6
11	Adjustable zipper/piping foot	FA9
12	Quilting foot	FA2
13	Walking foot	BLG-WF
14	1/4" quilting foot with guide	ESG-QFG
15	Needle set	X58358-021
16	Twin needle	X59296-121
17	Bobbin (4) (One is on machine)	X52800-120
18	Quilting guide	BLG-QG
19	Seam ripper	XF4967-001
20	Cleaning brush	X59476-051
21	Eyelet punch	XZ5051-001
22	Screwdriver (large)	XC4237-021
23	L-shaped screwdriver	XG0918-001
24	Disc-shaped screwdriver	XC1074-051
25	Horizontal spool pin	XC4654-151
26	Spool cap (large)	130012-024
27	Spool cap (medium) (2) (One is on machine)	XE1372-001
28	Spool cap (small)	130013-124
29	Thread spool insert (mini king thread spool)	XA5752-121
30	Spool net	XA5523-020
31	Knee lifter	XA6941-052
32	Bobbin case (on machine)	XG2058-001
33	Foot controller	XZ5100-001
34	Accessory bag	XC4487-021
35	Extension table	BLMAC-ET
36	Bobbin cover (with mark) (on machine)	XF0750-101
37	Bobbin cover	XE8992-101
38	Dust cover	XF9110-001
39	Power cord	XC6052-021
40	Instruction and Reference Guide	XG0017-001
41	Quick reference guide	XF9912-001

Note

- The presser foot holder screw is available through your authorized Babylock retailer. (Part code: XG1343-001)
- The presser foot accessory tray is available, through your authorized retailer. (Part code: XF8650-001)

◆ Optional Accessories

The following are available as optional accessories to be purchased separately from your authorized Baby Lock retailer.

No.	Part Name	Part Code
1	Free motion open toe quilting foot "O"	BLSR-FMO
2	Free motion echo quilting foot "E"	BLSR-FME
3	Free motion quilting foot "C"	BLSO-FMC
4	1/4" quilting foot	FA1
5	Side cutter "S"	BLG-SCF
6	Spool stand	BLMAC-ST5
7	Straight stitch foot and needle plate set	BLMAC-SS
8	Narrow hemmer foot	ESG-HF
9	Cording foot (3 cord guide)	BLG-CF3
10	Edge joining foot	ESG-EJF

Memo

- To obtain optional accessories or parts, contact your authorized Babylock retailer.
- All specifications are correct at the time of printing. Please be aware that some specifications may change without notice.
- Visit your nearest authorized Babylock retailer for a complete listing of optional accessories available for your machine.
- Always use accessories recommended for this machine.

◆ Accesorios incluidos

Nº	Nombre de la pieza	Código de la pieza
1	Pie para zig-zag "J" (en la máquina)	XF9671-001
2	Pie para monogramas "N"	XD0810-031
3	Pie para sobrehilado "G"	XC3098-031
4	Pie para cremalleras "I"	X59370-021
5	Pie para ojales "A"	XC2691-023
6	Pie para puntada invisible "R"	XE2650-001
7	Pie especial para botones "M"	XE2643-001
8	Pie de punta abierta	FA7
9	Pie antiadherente	FA8
10	Pie para guía de puntadas "P"	FA6
11	Pie ajustable para cremalleras/ ribetes	FA9
12	Pie para acolchados	FA2
13	Pie móvil	BLG-WF
14	Pie para acolchado de 1/4" con guía	ESG-QFG
15	Juego de agujas	X58358-021
16	Aguja gemela	X59296-121
17	Bobina (4) (Una está colocada en la máquina)	X52800-120
18	Guía de acolchados	BLG-QG
19	Abreojales	XF4967-001
20	Cepillo de limpieza	X59476-051
21	Lápiz calador	XZ5051-001
22	Destornillador (grande)	XC4237-021
23	Destornillador en forma de L	XG0918-001
24	Destornillador de disco	XC1074-051
25	Portacarrete horizontal	XC4654-151
26	Tapa del carrete (grande)	130012-024
27	Tapa del carrete (mediana) (2) (Una está colocada en la máquina)	XE1372-001
28	Tapa de carrete (pequeña)	130013-124
29	Inserción del carrete de hilo (carrete de hilo "mini king")	XA5752-121
30	Red para carrete	XA5523-020
31	Elevador de rodilla	XA6941-052
32	Caja de la bobina (en la máquina)	XG2058-001
33	Pedal	XZ5100-001
34	Bolsa de accesorios	XC4487-021
35	Tablero de extensión	BLMAC-ET
36	Tapa de la bobina (con marca) (en la máquina)	XF0750-101
37	Tapa de bobina	XE8992-101
38	Funda	XF9110-001
39	Cable de alimentación	XC6052-021
40	Guía de referencia y de instrucciones	Contacto con su distribuidor Baby Lock.
41	Guía de referencia rápida	XF9912-001

Nota

- Puede adquirir el tornillo del soporte del pie prensatela en su distribuidor Babylock autorizado. (Referencia: XG1343-001)
- Puede adquirir la bandeja de accesorios del pie prensatela en su distribuidor autorizado. (Referencia: XF8650-001)

◆ Accesorios opcionales

En la tabla siguiente se presentan los accesorios opcionales disponibles que pueden adquirirse por separado en su distribuidor Baby Lock autorizado.

Nº	Nombre de la pieza	Código de la pieza
1	Pie para acolchado libre de punta abierta "O"	BLSR-FMO
2	Pie para acolchado repetido libre "E"	BLSR-FME
3	Pie para acolchado libre "C"	BLSO-FMC
4	Pie para acolchado de 1/4"	FA1
5	Cuchilla lateral "S"	BLG-SCF
6	Pora hilos grande	BLMAC-ST5
7	Pie de costura recta y juego de placas de la aguja	BLMAC-SS
8	Pie para dobladillos estrechos	ESG-HF
9	Pie para cordones (guía de 3 cordones)	BLG-CF3
10	Pie para unir bordes	ESG-EJF

Recuerde

- Si desea obtener accesorios o piezas opcionales, póngase en contacto con su distribuidor Babylock autorizado.
- Todas las especificaciones son correctas en el momento de la publicación. Tenga en cuenta que algunas especificaciones pueden sufrir cambios sin previo aviso.
- Póngase en contacto con su distribuidor Babylock autorizado más cercano para obtener una lista completa de los accesorios opcionales disponibles para su máquina.
- Utilice siempre los accesorios recomendados para esta máquina.

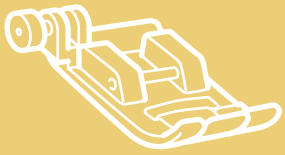

Accessoires

◆ Accessoires inclus

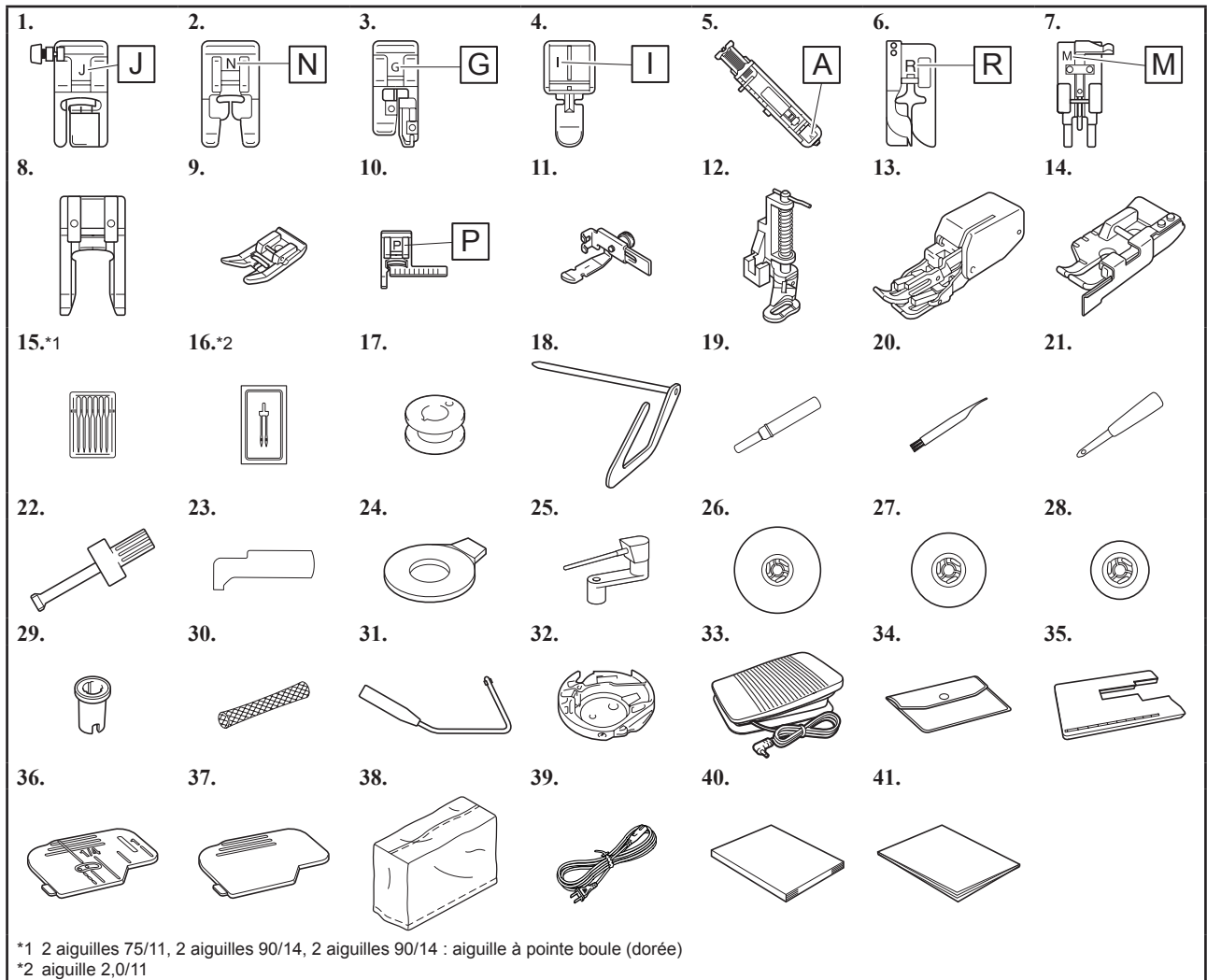

◆ Accessoires en option

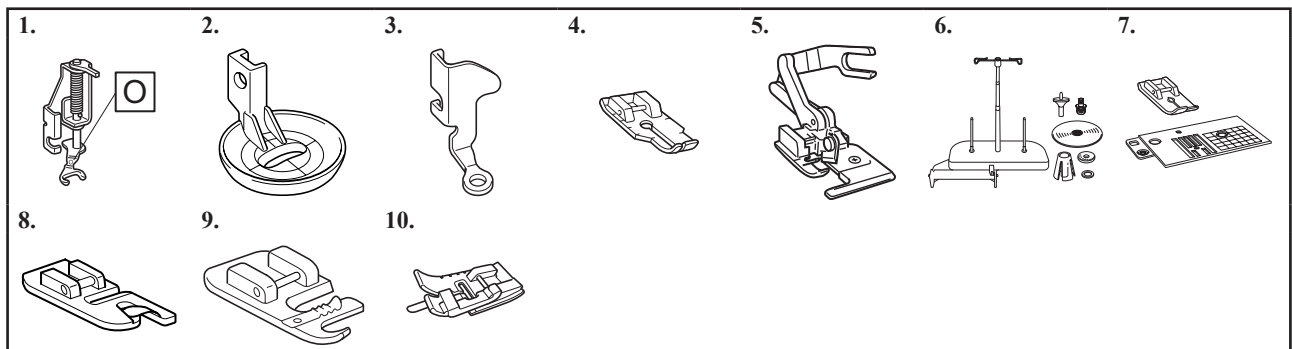

◆ Accessoires inclus

N°	Nom de la pièce	Code de la pièce
1	Pied zigzag « J » (sur la machine)	XF9671-001
2	Pied pour monogrammes « N »	XD0810-031
3	Pied pour faufilage « G »	XC3098-031
4	Pied pour fermetures à glissière « I »	X59370-021
5	Pied pour boutons « A »	XC2691-023
6	Pied pour point invisible « R »	XE2650-001
7	Pied pour boutons « M »	XE2643-001
8	Pied ouvert	FA7
9	Pied-de-biche non adhérent	FA8
10	Pied-de-biche de guidage de points « P »	FA6
11	Pied réglable pour fermetures à glissière/ passepoils	FA9
12	Pied pour quilting (courtepointe)	FA2
13	Pied à double entraînement	BLG-WF
14	Guide et pied pour quilting (courtepointe) 1/4" / pouce	ESG-QFG
15	Jeu d'aiguilles	X58358-021
16	Aiguille jumelée	X59296-121
17	Canette x 4 (l'une se trouve sur la machine)	X52800-120
18	Guide pour quilting (courtepointe)	BLG-QG
19	Découpeur	XF4967-001
20	Brosse de nettoyage	X59476-051
21	Perce-œillet	XZ5051-001
22	Tournevis (grand)	XC4237-021
23	Tournevis en forme de L	XG0918-001
24	Tournevis en forme de disque	XC1074-051
25	Porte-bobine horizontale	XC4654-151
26	Couvercle de bobine (grand)	130012-024
27	Couvercle de bobine (moyen) x 2 (l'un se trouve sur la machine)	XE1372-001
28	Couvercle de bobine (petit)	130013-124
29	Centre amovible pour bobine de fil (bobine de fil mini/très grand)	XA5752-121
30	Filet de la bobine	XA5523-020
31	Genouillère	XA6941-052
32	Boîtier de la canette (sur la machine)	XG2058-001
33	Pédale	XZ5100-001
34	Sac d'accessoires	XC4487-021
35	Table d'extension	BLMAC-ET
36	Capot du compartiment à canette (avec un repère) (sur la machine)	XF0750-101
37	Capot du compartiment à canette	XE8992-101
38	Housse	XF9110-001
39	Cordon d'alimentation	XC6052-021
40	Guide d'instructions et de référence	Contactez votre revendeur Baby Lock.
41	Guide de référence rapide	XF9912-001



Remarque

- La vis du support du pied-de-biche est disponible auprès de votre revendeur Babylock agréé. (code de référence : XG1343-001)
- Le tiroir d'accessoires pour pied-de-biche est disponible auprès de votre revendeur agréé. (code de référence : XF8650-001)

◆ Accessoires en option

Les éléments suivants sont des accessoires en option vendus séparément par votre revendeur Baby Lock agréé.

N°	Nom de la pièce	Code de la pièce
1	Pied pour quilting (courtepointe) ouvert en mouvement libre « O »	BLSR-FMO
2	Pied pour quilting (courtepointe) en écho en mouvement libre « E »	BLSR-FME
3	Pied pour quilting (courtepointe) en mouvement libre « C »	BLSO-FMC
4	Pied pour quilting (courtepointe) 1/4" / pouce	FA1
5	Couteau raseur « S »	BLG-SCF
6	Porte multi-bobines	BLMAC-ST5
7	Ensemble pied pour point droit et plaque à aiguille	BLMAC-SS
8	Pied ourleur étroit	ESG-HF
9	Pied pour cordonnet (guide 3 cordonnets)	BLG-CF3
10	Pied pour l'assemblage des bords	ESG-EJF



Mémo

- Pour obtenir les pièces ou les accessoires en option, contactez votre revendeur Babylock agréé.
- Toutes les spécifications sont correctes à la date d'impression de ce document. Certaines spécifications peuvent être modifiées sans avis préalable.
- Consultez votre revendeur Babylock agréé le plus proche pour obtenir la liste complète des accessoires en option pour votre machine.
- Utilisez toujours des accessoires recommandés pour cette machine.



Bobbin Winding and Setting

Bobinado y ajuste

Bobinage et réglage de la canette

Follow the steps below, in numerical order. Refer to the instruction and reference guide for detailed instructions.
 Siga los pasos descritos a continuación, en orden numérico. Consulte las instrucciones detalladas en la guía de referencia y de instrucciones.
 Respectez les étapes ci-dessous, dans l'ordre numérique. Reportez-vous au guide d'instructions et de référence pour des informations détaillées.

Use only the included bobbin or bobbins of the same type.
 Utilice solo la bobina incluida, o bobinas del mismo tipo.
 N'utilisez que la canette fournie ou des canettes du même type.

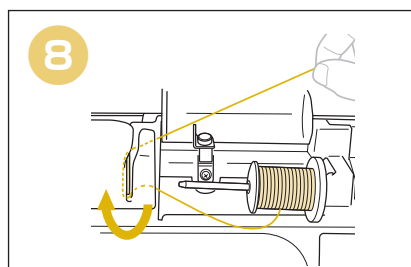
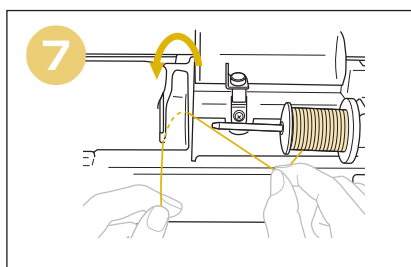
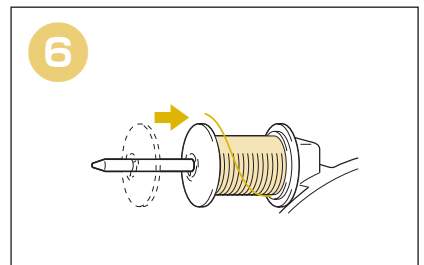
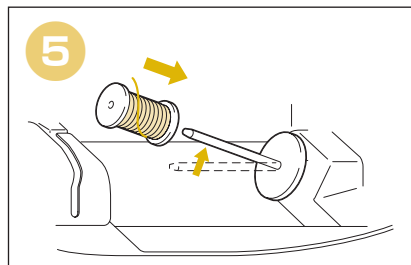
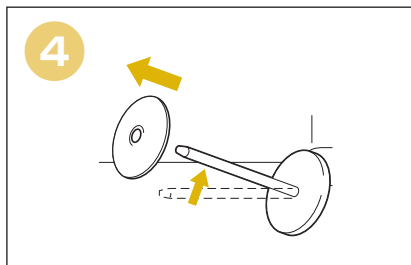
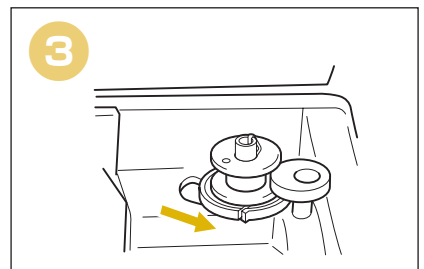
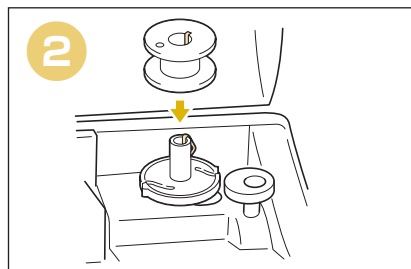
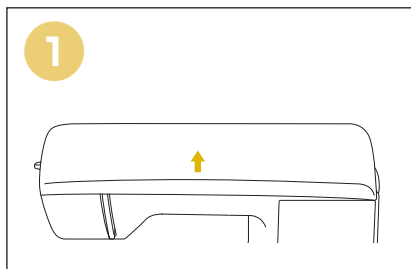
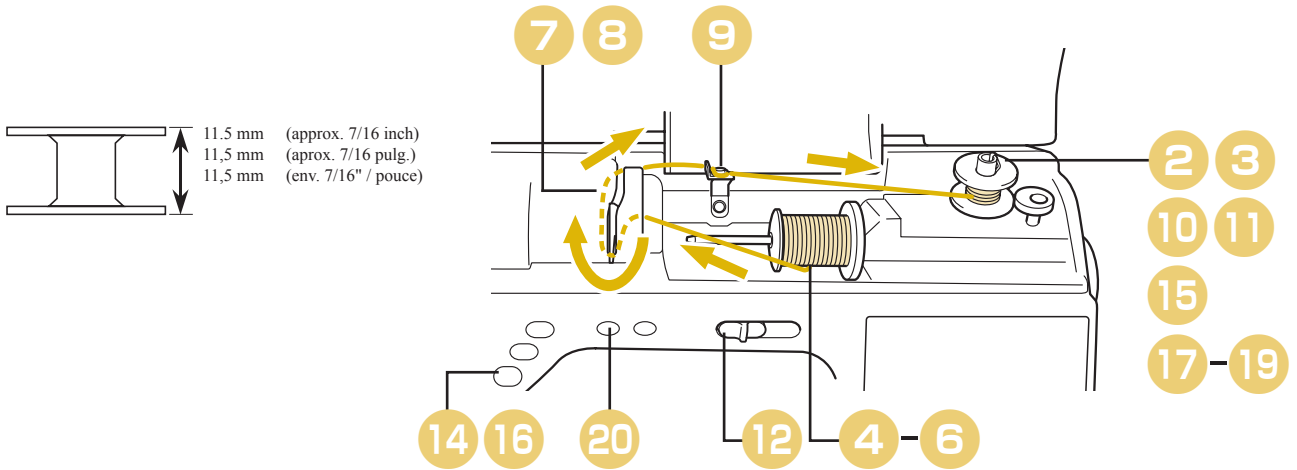

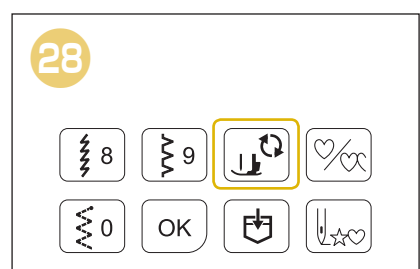
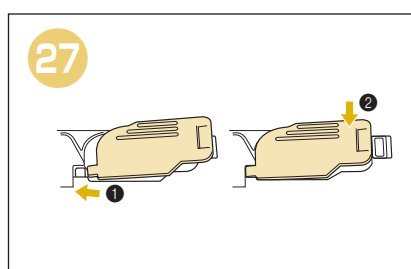
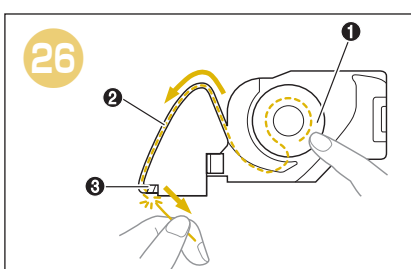
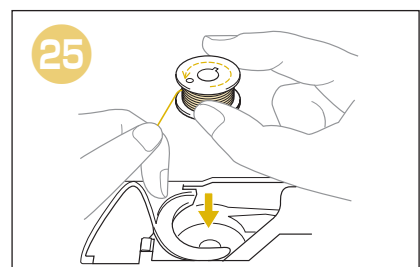
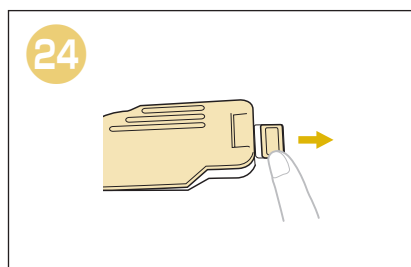
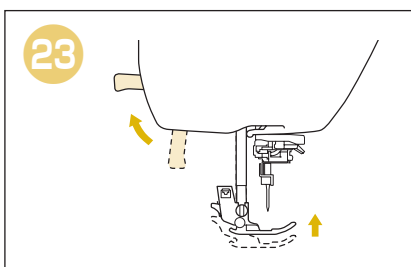
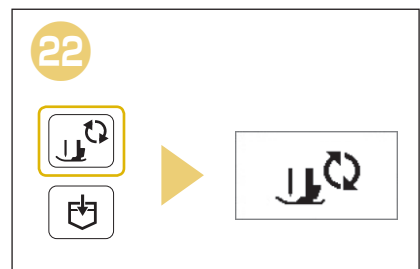
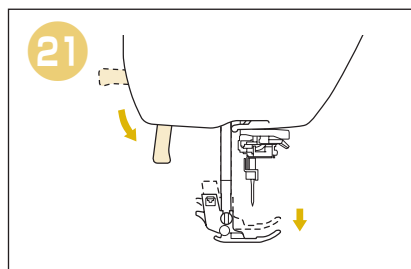
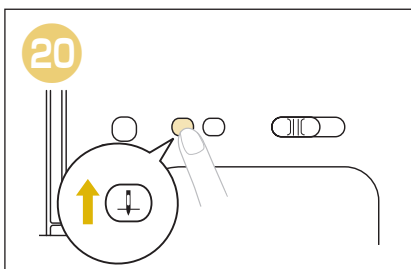
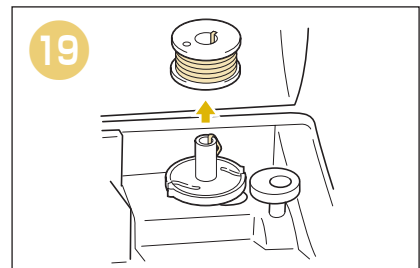
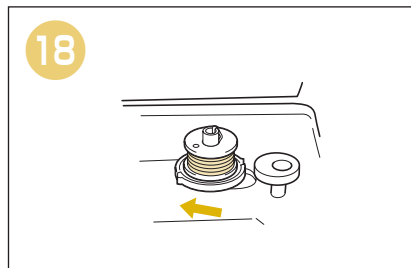
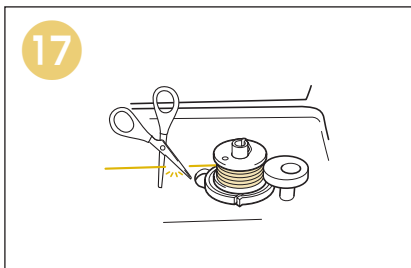
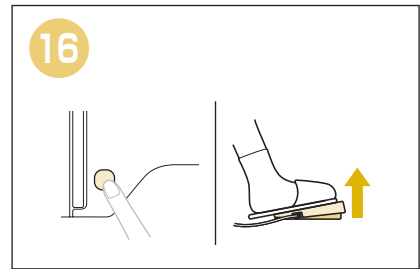
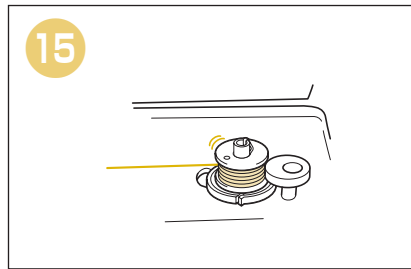
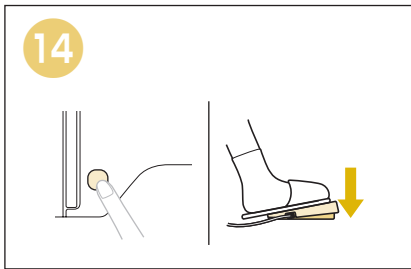
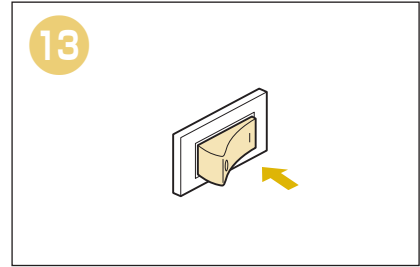
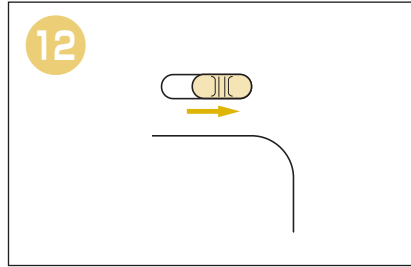
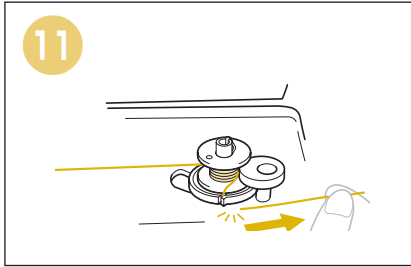
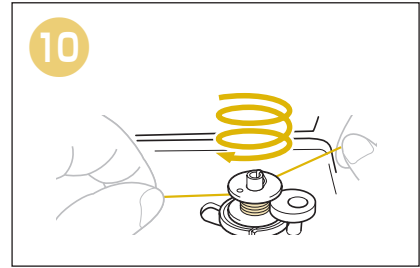
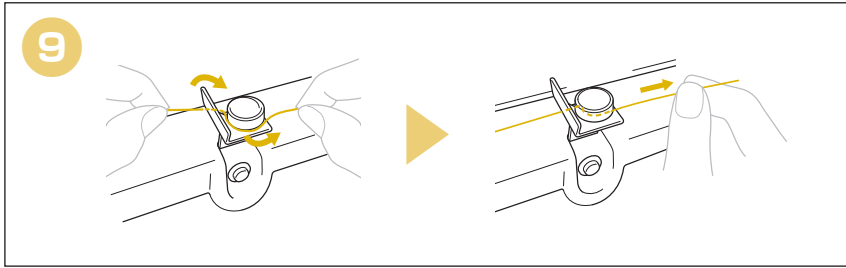



Upper Threading Hilo superior Enfilage supérieur

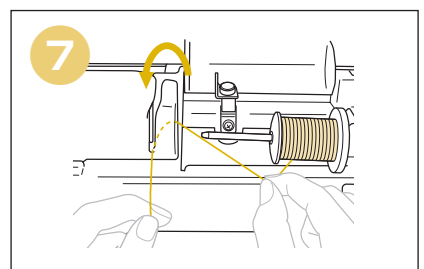
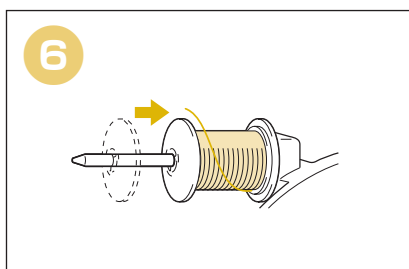
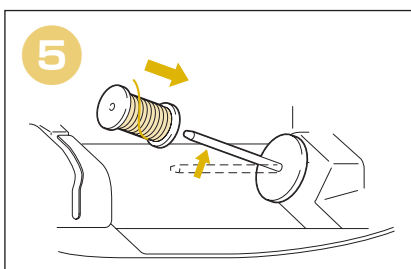
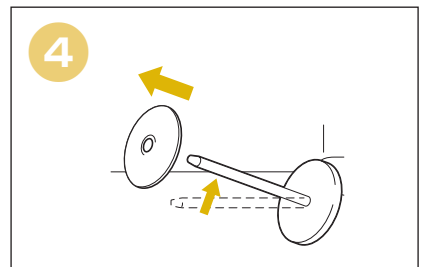
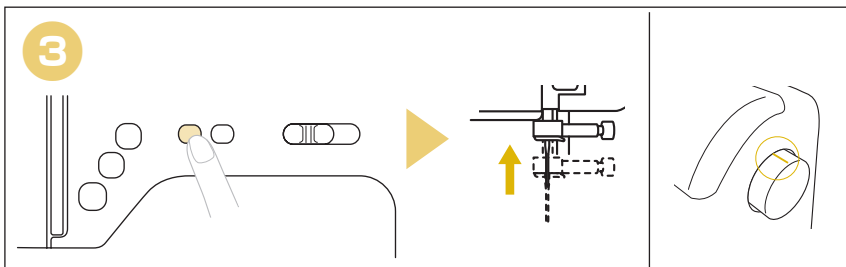
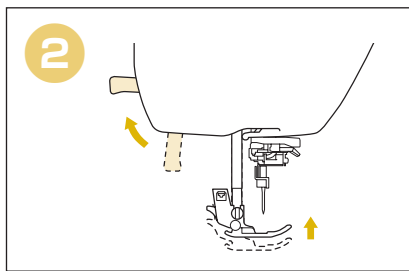
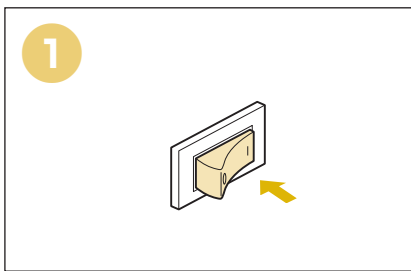
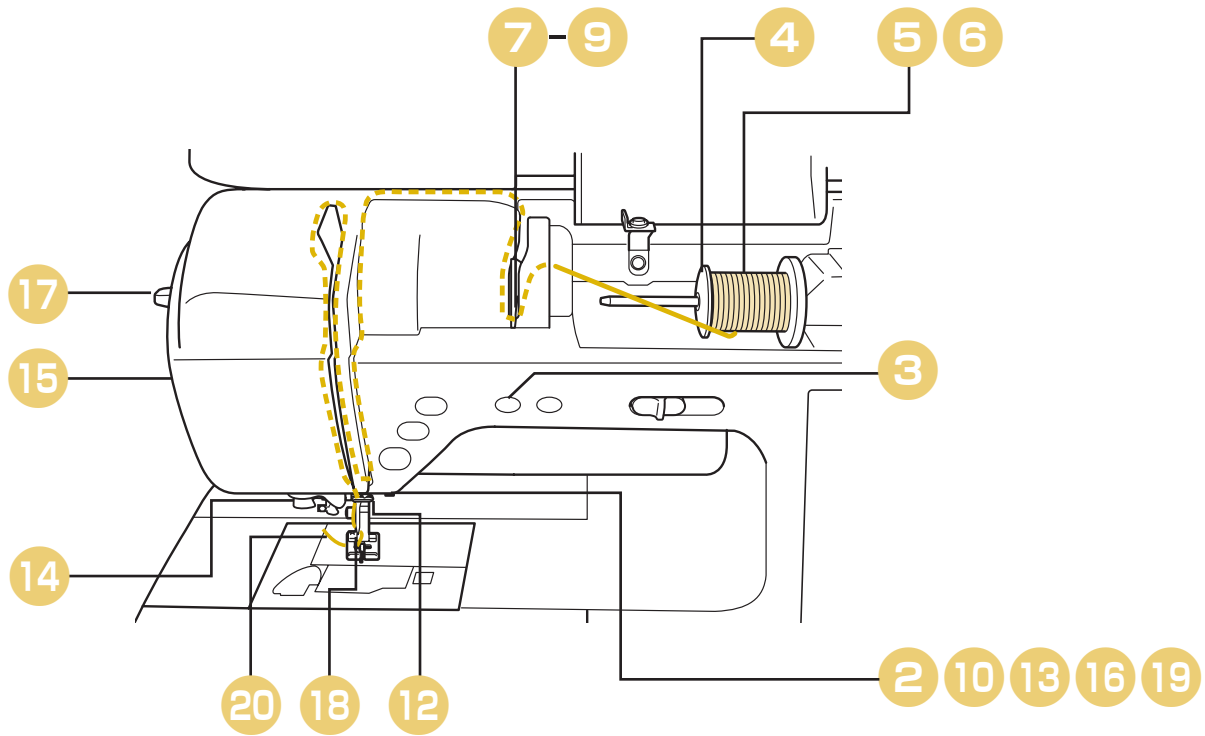

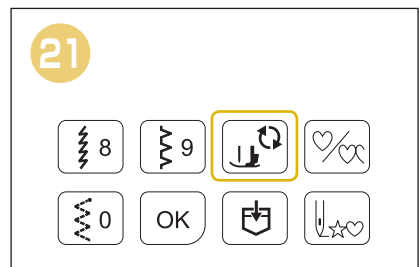
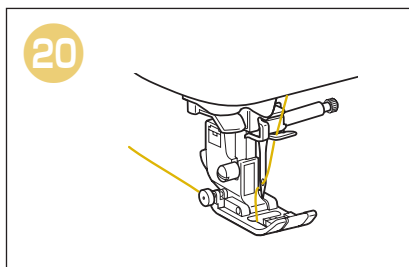
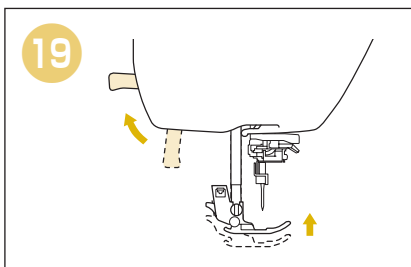
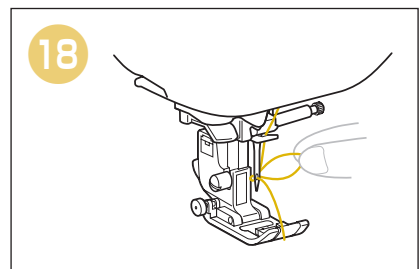
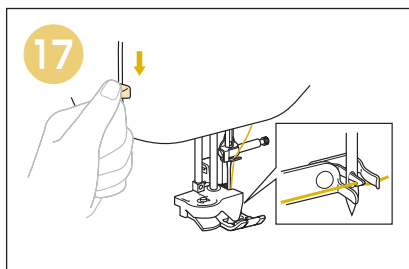
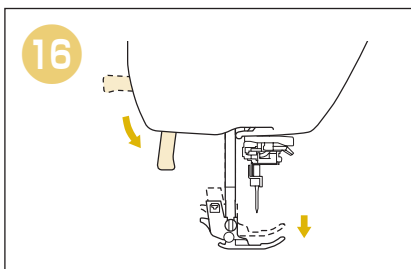
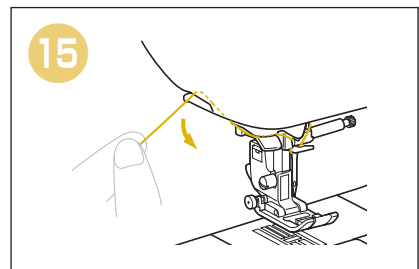
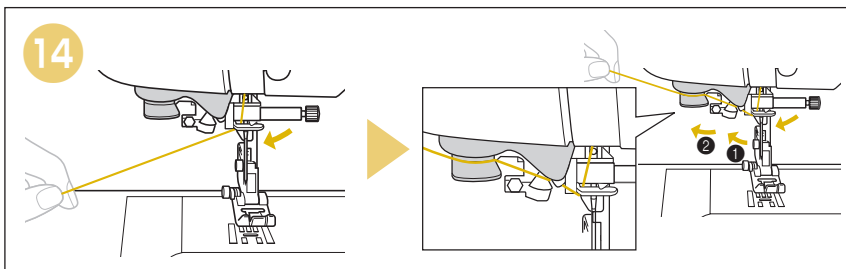
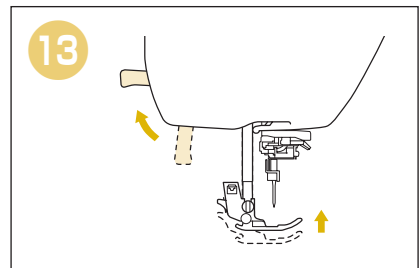
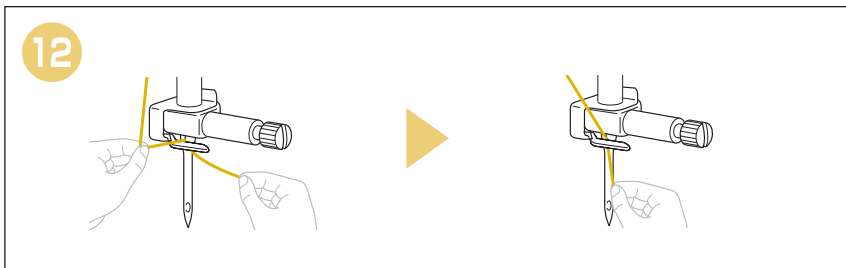
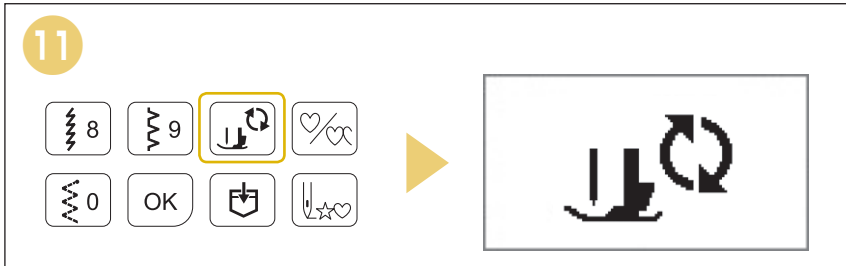
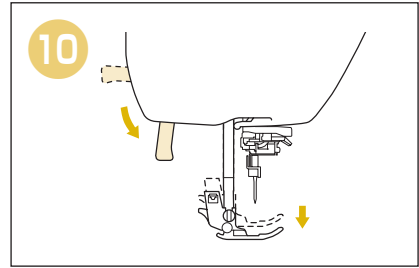
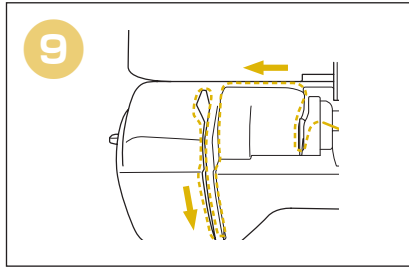
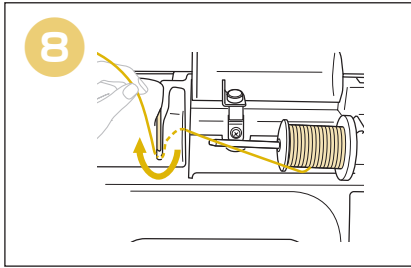



Name of Machine Parts Nombres de las piezas de la máquina Nom des pièces de la machine

◆ Operation buttons ◆ Botones de operación ◆ Touches de commande

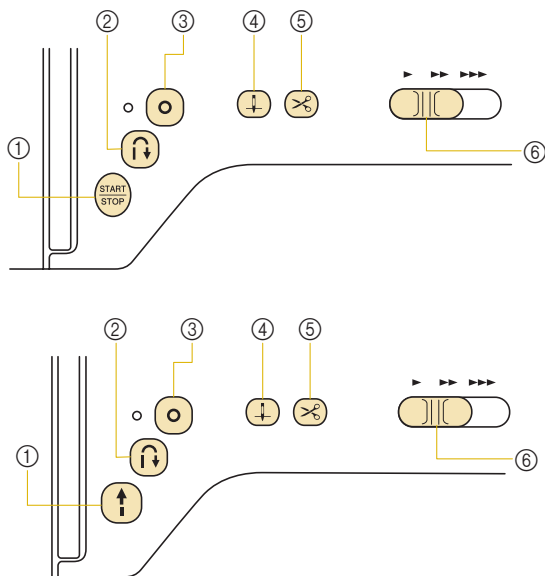

- ① "Start/Stop" button
- ② Reverse stitch button
- ③ Reinforcement stitch button
- ④ Needle position button
- ⑤ Thread cutter button
- ⑥ Sewing speed controller/Width control

- ① Botón de "inicio/parar"
- ② Botón de puntada en reversa
- ③ Botón de puntada de remate
- ④ Botón de posición de aguja
- ⑤ Botón de corte de hilo
- ⑥ Control de velocidad manual/Control de anchura

- ① Touche « Marche/arrêt »
- ② Touche Point inverse
- ③ Touche Point de renfort
- ④ Touche Positionnement aiguille
- ⑤ Touche Coupe-fil
- ⑥ Commande de vitesse de couture/Contrôle de la largeur

◆ Operation panel ◆ Panel de operaciones ◆ Panneau de commande

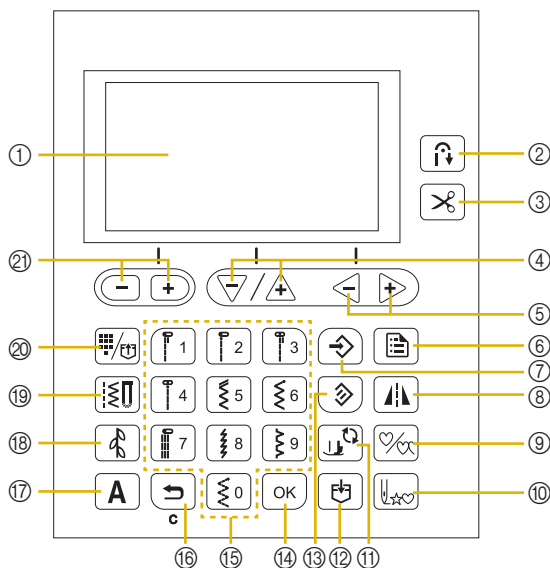

- ① LCD (liquid crystal display)
- ② Automatic reverse/reinforcement key
- ③ Automatic thread cutting key
- ④ Stitch length keys/Item selection keys
- ⑤ Thread tension keys/Value selection keys
- ⑥ Settings key
- ⑦ Manual memory key
- ⑧ Mirror image key
- ⑨ Single/repeat sewing key
- ⑩ Back to beginning key
- ⑪ Presser foot/Needle exchange key
- ⑫ Memory key
- ⑬ Reset key
- ⑭ OK key
- ⑮ Numeric keys
- ⑯ Back key
- ⑰ Character stitch key
- ⑱ Decorative stitch key
- ⑲ Utility stitch key
- ⑳ Preset utility stitch/saved pattern key
- ㉑ Stitch width keys/Settings screen page selection keys

- ① Pantalla LCD (pantalla de cristal líquido)
- ② Tecla de puntada en reversa/remate automática
- ③ Tecla de corte automático de hilo
- ④ Teclas de longitud de la puntada/Teclas de selección de elemento
- ⑤ Teclas de tensión del hilo/Teclas de selección del valor
- ⑥ Tecla de ajustes
- ⑦ Tecla de memoria manual
- ⑧ Tecla de efecto espejo
- ⑨ Tecla de costura sencilla/doble
- ⑩ Tecla para volver al principio
- ⑪ Tecla de cambio del pie prensatela/aguja
- ⑫ Tecla de memoria
- ⑬ Tecla de borrado
- ⑭ Tecla Aceptar
- ⑮ Teclas numéricas
- ⑯ Tecla de retroceso
- ⑰ Tecla de puntada de carácter
- ⑱ Tecla de puntada decorativa
- ⑲ Tecla de puntada de utilidad
- ⑳ Tecla de puntada de utilidad predefinida/patrón guardado
- ㉑ Teclas de anchura de la puntada/Teclas de selección de página de la pantalla de ajustes

- ① Écran à cristaux liquides
- ② Touche de point inverse/de renfort automatique
- ③ Touche de coupure de fil automatique
- ④ Touches de longueur de point/Touches de sélection d'élément
- ⑤ Touches de tension du fil/Touches de sélection de valeur
- ⑥ Touche de réglages
- ⑦ Touche de mémoire manuelle
- ⑧ Touche d'image en miroir
- ⑨ Touche de couture en points uniques/en continu
- ⑩ Retour à la touche de début
- ⑪ Touche de remplacement du pied-de-biche/de l'aiguille
- ⑫ Touche de mise en mémoire
- ⑬ Touche de réinitialisation
- ⑭ Touche OK
- ⑮ Touches numériques
- ⑯ Touche arrière
- ⑰ Touche de points de caractères
- ⑱ Touche de points décoratifs
- ⑲ Touche de points de couture courants
- ⑳ Touche de préréglage de point de couture courant/motif enregistré
- ㉑ Touches de largeur de point/Touches de sélection des pages de l'écran de réglages

◆ Settings screen ◆ Pantalla de ajustes ◆ Écran de réglages

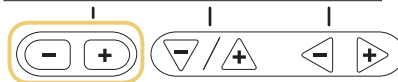
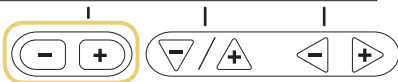
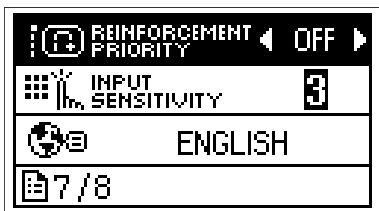
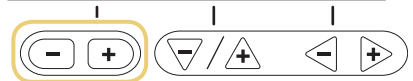
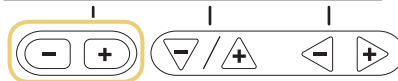
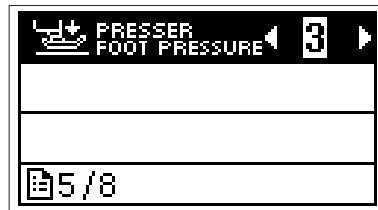
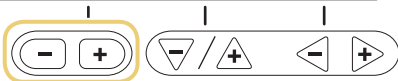
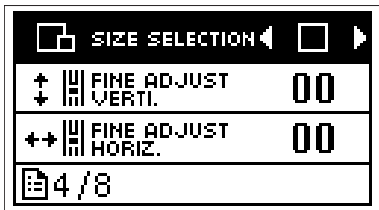
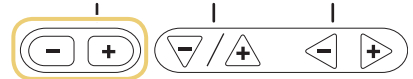
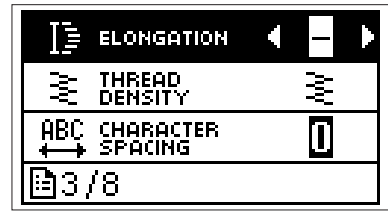
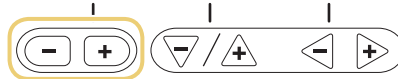
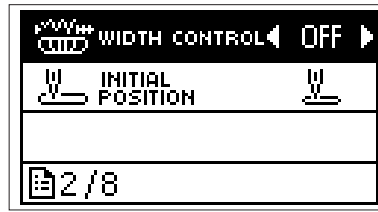
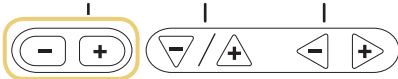
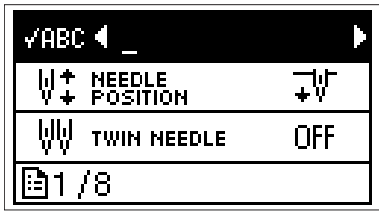
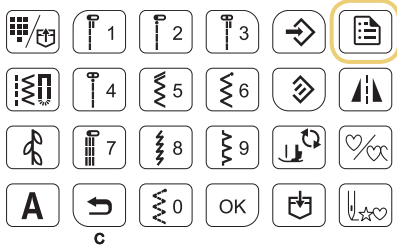

Selecting and Sewing Patterns

Seleccionar y coser patrones

Sélection et couture de motifs

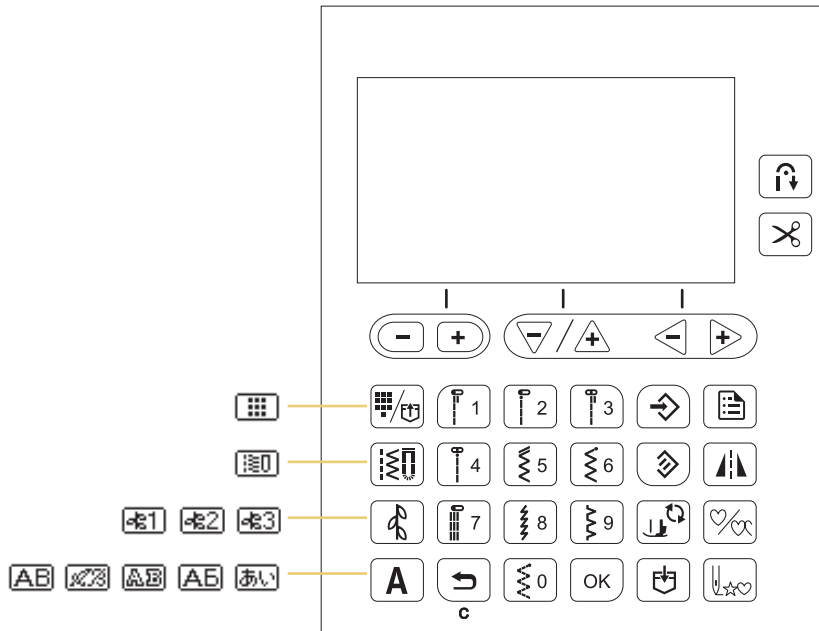

◆ Preset Utility Stitches ◆ Puntadas de utilidad predefinidas ◆ Préréglage des points de couture courants

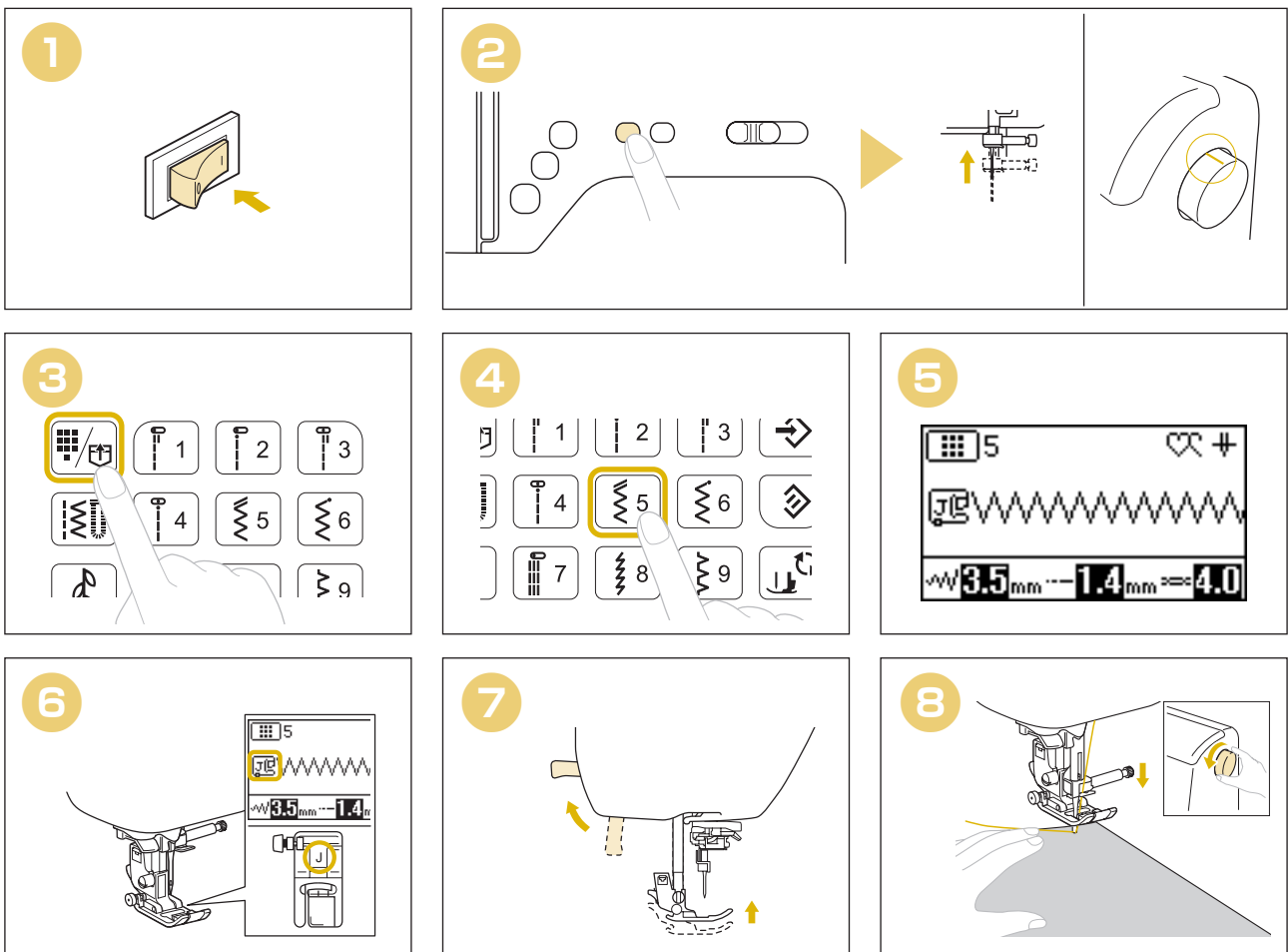

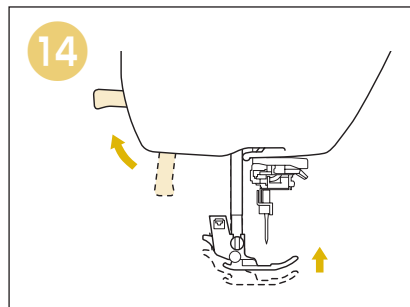
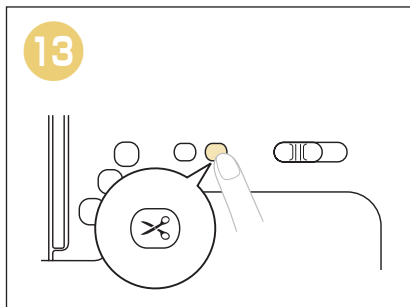
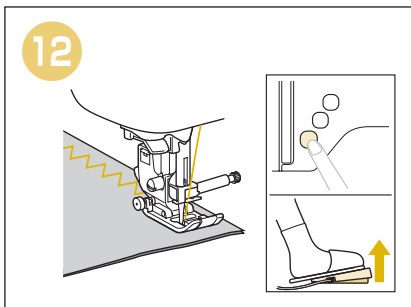
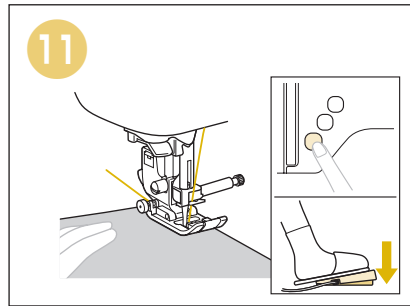
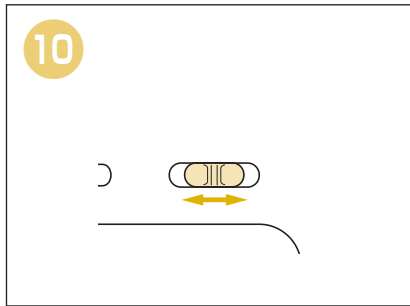
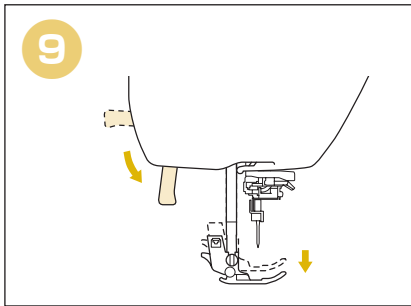

◆ Utility Stitches

◆ Puntadas de utilidad

◆ Points de couture courants

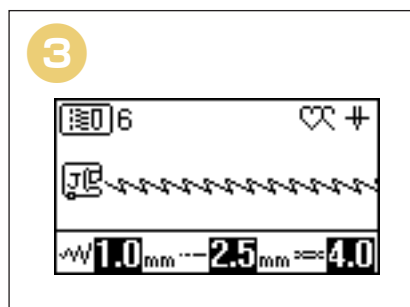
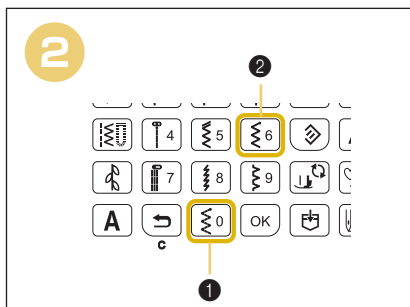
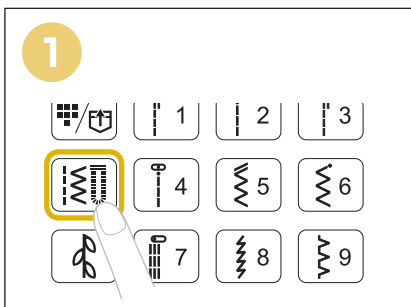

◆ Decorative Stitches ◆ Puntadas decorativas ◆ Points décoratifs

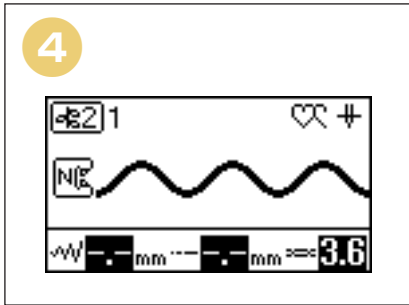
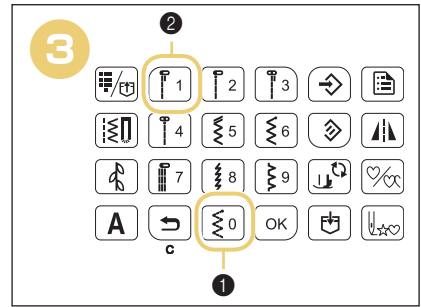
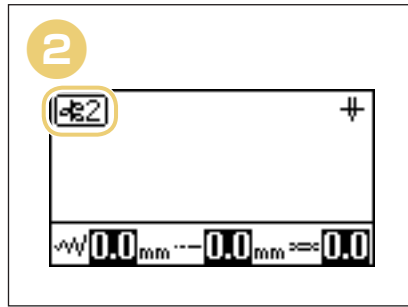
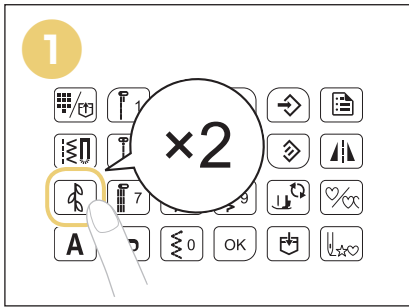

◆ Character stitches ◆ Puntadas de carácter ◆ Points de caractères

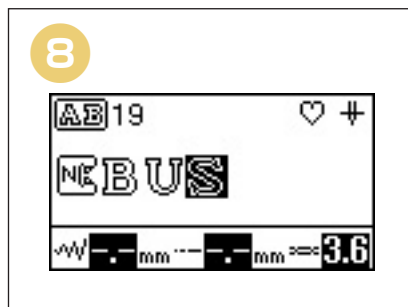
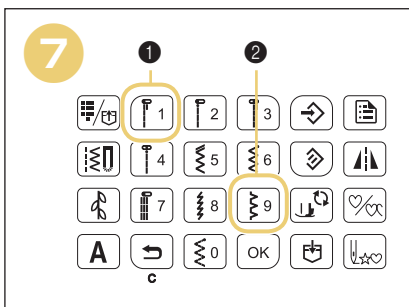
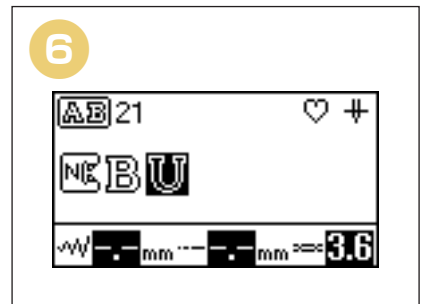
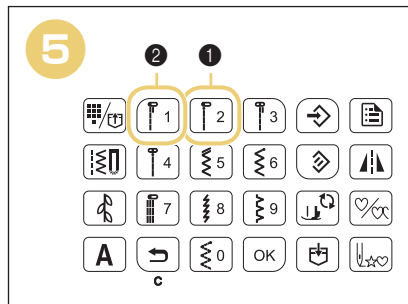
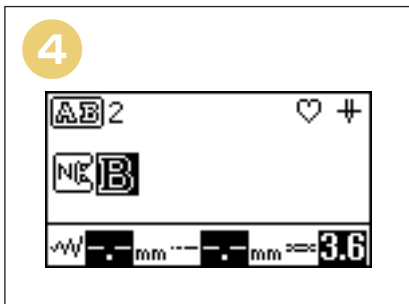
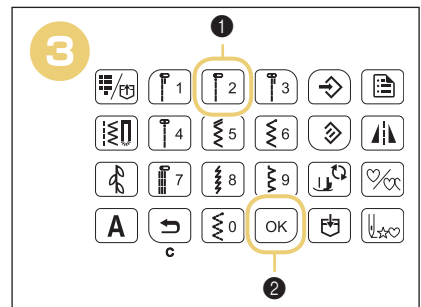
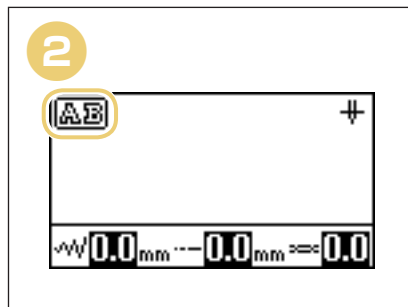
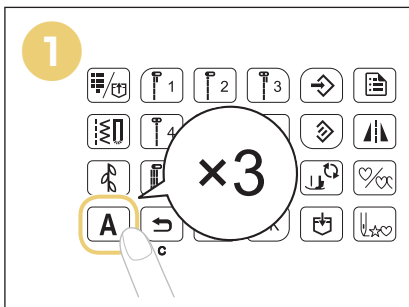



Summary of Stitch Patterns

Resumen de tipos de puntada

Sommaire des motifs de point

◆ Preset Utility Stitches ◆ Puntadas de utilidad predefinidas ◆ Préréglage des points de couture courants

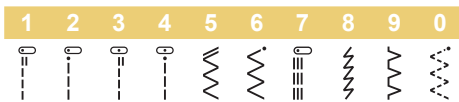

◆ Utility Stitches ◆ Puntadas de utilidad ◆ Points de couture courants

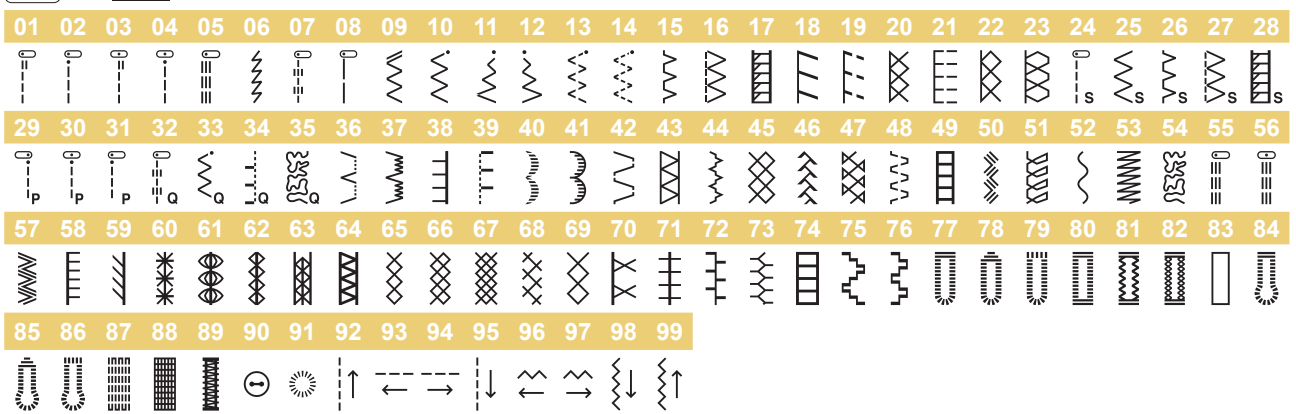

◆ Decorative Stitches ◆ Puntadas decorativas ◆ Points décoratifs



×1



● Decorative Stitches

● Puntadas decorativas

● Points décoratifs



* 36: Pattern for making adjustment, 98, 99: Pattern for step function

* 36: Patrón para hacer el ajuste, 98, 99: Patrón para la puntada escalonada

* 36 : Motif d'ajustement, 98, 99 : Motifs de points en dégradé

 x2 ▶ 

● Satin stitches (01-12)
7 mm satin stitches (13-29)
Cross stitch stitches (30-43)

● Costuras para satén (01-12)
Puntadas satinadas de 7 mm (13-29)
Puntadas de punto de cruz (30-43)

● Points plumetis (01-12)
Points plumetis 7 mm (13-29)
Points de croix (30-43)

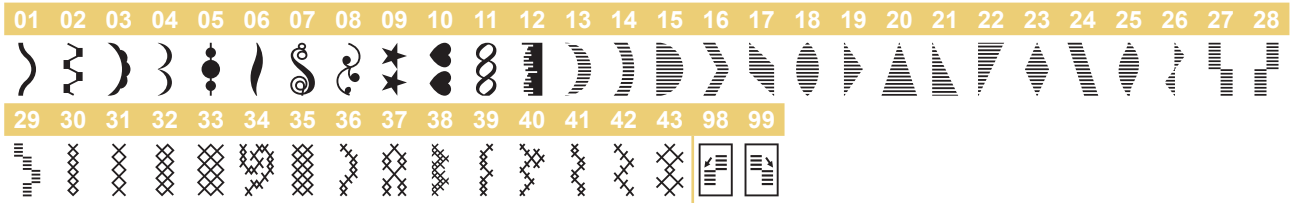

* 98, 99: Pattern for step function

* 98, 99: Patrón para la puntada escalonada

* 98, 99 : Motifs de points en dégradé

 x3 ▶ 

● Utility decorative stitch patterns

● Puntadas decorativas utilitarias

● Motifs de points décoratifs courants

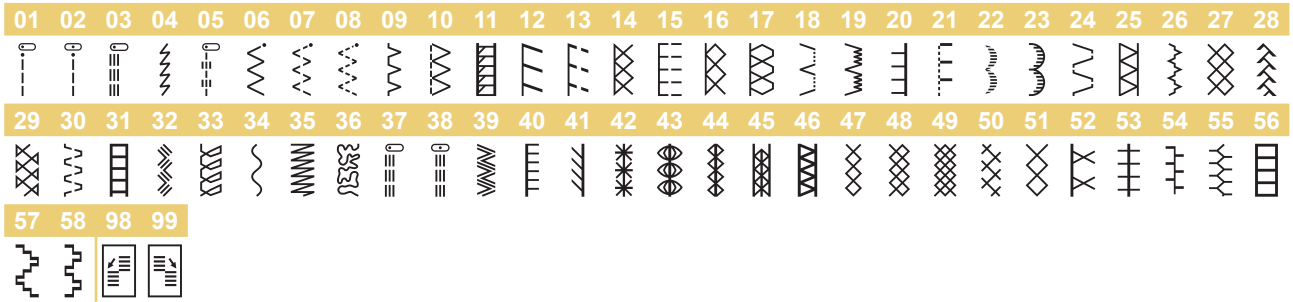

* 98, 99: Pattern for step function

* 98, 99: Patrón para la puntada escalonada

* 98, 99 : Motifs de points en dégradé

◆ Character Stitches ◆ Puntadas de carácter ◆ Points de caractères

 x1 ▶ 

● Gothic font

● Fuente gótica

● Police gothique



A x2 ▶ 

● Handwriting font

● Fuente de escritura a mano

● Police manuscrite

1	2	3	4	5	6	7	8	9	10	11	12	13	14	15	16	17	18	19	20	21	22	23	24	25	26
A	B	C	D	E	F	G	H	I	J	K	L	M	N	O	P	Q	R	S	T	U	V	W	X	Y	Z
27	28	29	30	31	32	33	34	35	36	37	38	39	40	41	42	43	44	45	46	47	48	49	50	51	52
a	b	c	d	e	f	g	h	i	j	k	l	m	n	o	p	q	r	s	t	u	v	w	x	y	z
53	54	55	56	57	58	59	60	61	62	63	64	65	66	67	68	69	70	71	72	73	74	75	76	77	78
0	1	2	3	4	5	6	7	8	9	#	%	\$	£	€	¥	-	+	×	÷	=	*	.	,	&	?
79	80	81	82	83	84	85	86	87	88	89	90	91	92	93	94	95	96	97	98	99	100	101	102	103	104
!	@	<	>	()	[]	/	\	~	:	:	©	®	™	“	”	”	’	‘	’	—	À	Á	Â
105	106	107	108	109	110	111	112	113	114	115	116	117	118	119	120	121	122	123	124	125	126	127	128	129	130
Æ	à	á	â	ã	ä	å	æ	ç	ç	Ð	È	É	Ê	Ë	è	é	ê	ë	í	ÿ	ì	í	î	ï	ÿ
131	132	133	134	135	136	137	138	139	140	141	142	143	144	145	146	147	148	149	150	151	152	153	154	155	156
Ñ	Ñ	ñ	ô	ö	ø	œ	ø	ø	ø	ø	ø	ø	ø	ø	ø	ø	ø	ø	ø	ø	ø	ø	ø	ø	ø

157
ß

A x3 ▶ 

● Outline

● Con borde

● Contour

1	2	3	4	5	6	7	8	9	10	11	12	13	14	15	16	17	18	19	20	21	22	23	24	25	26
A	B	C	D	E	F	G	H	I	J	K	L	M	N	O	P	Q	R	S	T	U	V	W	X	Y	Z
27	28	29	30	31	32	33	34	35	36	37	38	39	40	41	42	43	44	45	46	47	48	49	50	51	52
a	b	c	d	e	f	g	h	i	j	k	l	m	n	o	p	q	r	s	t	u	v	w	x	y	z
53	54	55	56	57	58	59	60	61	62	63	64	65	66	67	68	69	70	71	72	73	74	75	76	77	78
0	1	2	3	4	5	6	7	8	9	#	%	\$	£	€	¥	-	+	×	÷	=	*	.	,	&	?
79	80	81	82	83	84	85	86	87	88	89	90	91	92	93	94	95	96	97	98	99	100	101	102	103	104
!	@	<	>	()	[]	/	\	~	:	:	©	®	™	“	”	”	’	‘	’	—	À	Á	Â
105	106	107	108	109	110	111	112	113	114	115	116	117	118	119	120	121	122	123	124	125	126	127	128	129	130
Æ	à	á	â	ã	ä	å	æ	ç	ç	Ð	È	É	Ê	Ë	è	é	ê	ë	í	ÿ	ì	í	î	ï	ÿ
131	132	133	134	135	136	137	138	139	140	141	142	143	144	145	146	147	148	149	150	151	152	153	154	155	156
Ñ	Ñ	ñ	ô	ö	ø	œ	ø	ø	ø	ø	ø	ø	ø	ø	ø	ø	ø	ø	ø	ø	ø	ø	ø	ø	ø

157
ß

A ×4 ▶ **АБ**

● Cyrillic font

● Fuente cirílica

● Police cyrillique

1	2	3	4	5	6	7	8	9	10	11	12	13	14	15	16	17	18	19	20	21	22	23	24	25	26
А Б В Г Д Е Ё Ж З И Й К Л М Н О П Р С Т У Ф Х Ц Ч Ш																									
27	28	29	30	31	32	33	34	35	36	37	38	39	40	41	42	43	44	45	46	47	48	49	50	51	52
Щ Ъ Ы Ь Э Ю Я Г Е І і Ў Ӧ ӧ Ј Љ Њ Ц Ѓ С К а б в г д																									
53	54	55	56	57	58	59	60	61	62	63	64	65	66	67	68	69	70	71	72	73	74	75	76	77	78
е ё ж з и й к л м н о п р с т у ф х ц ч ш щ ъ ы ь э																									
79	80	81	82	83	84	85	86	87	88	89	90	91	92	93	94	95	96	97	98	99	100	101	102	103	104
ю я г е і і ў ӧ ӧ ј љ њ ц ѓ с к 0 1 2 3 4 5 6 7 8 9																									
105	106	107	108	109	110	111	112	113	114	115															
— . , & ? ! () / ' _																									

A ×5 ▶ **あい**

● Japanese font

● Fuente japonesa

● Police japonaise

1	2	3	4	5	6	7	8	9	10	11	12	13	14	15	16	17	18	19	20	21	22	23	24	25	26
あいうえおあいうえおかきくけこがぎぐげごさしすせそざ																									
27	28	29	30	31	32	33	34	35	36	37	38	39	40	41	42	43	44	45	46	47	48	49	50	51	52
じずぜぞたちつてとだちづでどっなにぬねのはひふへほば																									
53	54	55	56	57	58	59	60	61	62	63	64	65	66	67	68	69	70	71	72	73	74	75	76	77	78
びぶべぼぱびぷぺぽまみむめもやゆよゃゅょらりるれろわ																									
79	80	81	82	83	84	85	86	87	88	89	90	91	92	93	94	95	96	97	98	99	100	101	102	103	104
をんアイウエオァィウヱォヴカキクケコガギグゲゴサシス																									
105	106	107	108	109	110	111	112	113	114	115	116	117	118	119	120	121	122	123	124	125	126	127	128	129	130
セソザジズゼゾタチツテトダヂヅデドッナニヌネノハヒフ																									
131	132	133	134	135	136	137	138	139	140	141	142	143	144	145	146	147	148	149	150	151	152	153	154	155	156
へほバビブベボパピプペポマミムメモヤユヨゃゅょラリル																									
157	158	159	160	161	162	163	164	165	166	167	168	169	170	171	172	173	174	175	176	177	178	179	180	181	182
レロフヲン0 1 2 3 4 5 6 7 8 9 〇 ー 二 三 四 五 六 七 八 九 十																									
183	184	185	186	187	188	189	190	191	192	193	194	195	196	197	198	199	200	201	202	203	204	205	206	207	208
& ? ! () ー 生 年 月 日 才 保 育 幼 稚 園 小 中 学 校 組 部 火 水 木 金																									
209	210																								
土 _																									

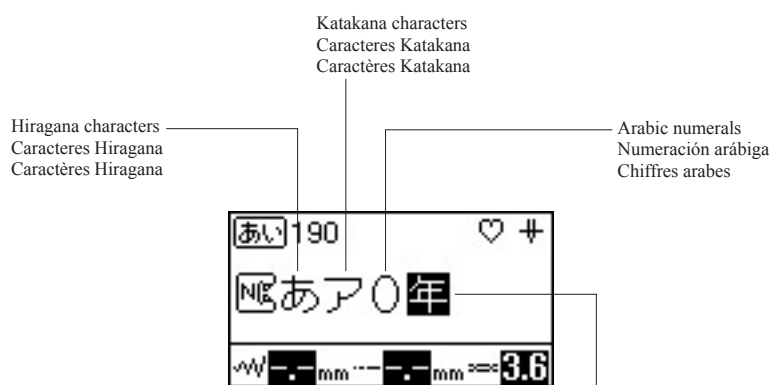

Kanji characters often used in daily life.
 Carácterés Kanji utilizados a menudo en el día a día.
 Caractères Kanji : souvent utilisés dans la vie de tous les jours.

- Example of Kanji characters in daily life
- Ejemplo de caracteres Kanji en la vida cotidiana
- Exemple de caractères Kanji dans la vie quotidienne

一 二 三 四 五 六 七 八 九 十

1, 2, 3, 4, 5, 6, 7, 8, 9, 10

生 年 月 日

Date of birth

Fecha de nacimiento

Date de naissance

一 才

1 year old

1 año de edad

1 an

保 育 園

Nursery school

Guardería

Crèche

幼 稚 園

Kindergarten

Jardín de infancia

École maternelle

小 学 校

Elementary school

Escuela primaria

École primaire

中 学 校

Junior high school

Escuela secundaria

Collège

組

Group/Class

Grupo/Clase

Groupe/Classe

部

Club/Division

Club/División

Club/Division

月

Moon/Monday

Luna/Lunes

Lune/Lundi

火

Fire/Tuesday

Fuego/Martes

Feu/Mardi

水

Water/Wednesday

Agua/Miércoles

Eau/Mercredi

木

Tree/Thursday

Árbol/Jueves

Arbre/Jeudi

金

Gold/Friday

Oro/Viernes

Or/Vendredi

土

Soil/Saturday

Tierra/Sábado

Terre/Samedi

日

Sun/Sunday

Sol/Domingo

Soleil/Dimanche

一 月 一 日 (月)

January 1st (Monday)

1 de enero (lunes)

1er janvier (lundi)

English
Spanish
French
888-F61
Printed in Vietnam



XF9912-101①