



**Owner's Manual  
For  
Sit Down**

Dec 2013

## Table of Contents

Warranty .....	3
Your Light Fixture .....	4
Attaching the Belt Guard .....	4
Your Thread Stand .....	5
Control panel .....	6
Needle position .....	7
Speed Setting .....	8
What is the Tension Release Lever?.....	9
How Do I Adjust the Height of the Hopping Foot? .....	9
Routine Cleaning and Oiling.....	10
Bobbin Winder and Bobbins .....	11
Machine Part Names.....	14
Threading Overview .....	15
How Do I Thread the Machine? .....	15
How Do I Change the Needle? .....	17
How Do I Make Adjustments to Make the Perfect Stitch? .....	18
<i>Tension, Tension, Tension</i> .....	19
Trouble Shooting Checklist	
Check spring replacement .....	21
Timing .....	23

## Warranty

We believe that we have designed and are manufacturing the best long arm quilting machine available. As you unpack your machine be sure to keep the box and packing materials designed to protect the machine during shipping. Should it become necessary for you to return the machine for warranty work please call us for specific instructions for packing and shipping your machine.

- Your Artistic Quilter SD Sit Down has a full warranty for one year from the day you receive your machine. We guarantee the machine parts for five years.
- The machine must be cleaned and oiled regularly according to the instructions in this manual. Failure to properly maintain the machine will void this warranty.
- Your Artistic Quilter SD Sit Down must be plugged into a surge protected electrical outlet.
- Should we mutually decide that your machine cannot be repaired using normal communications we will arrange for call tags to be sent to you for pick up of the machine.

## How to Contact Us

Should you have a problem with your machine, call the dealer who sold you the machine.



## Your Light Fixture

To add your light fixture to your machine, first loosen the nut and washer from the base of the light fixture,

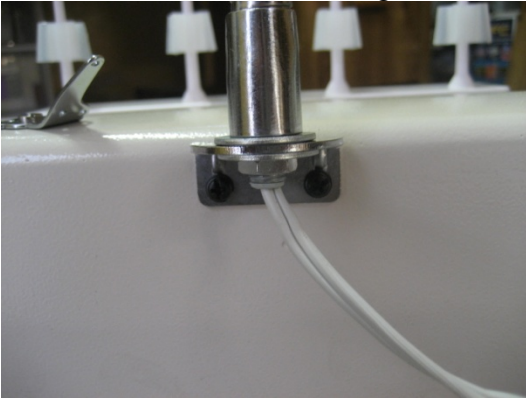

Slide the lamp base in to the lamp holder on the side of the machine.

Your light fixture came with a long cord. At this time you can trim the cord so that it will reach the outlet on cord side of the power box.

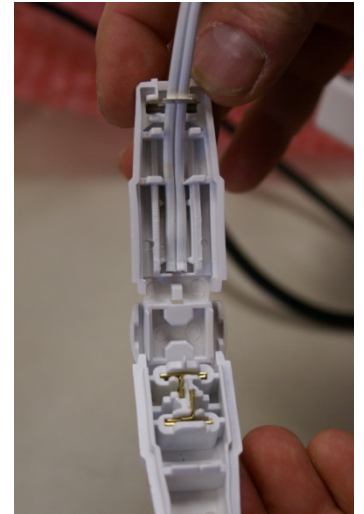

Open your plug by pulling on the silver tab and open the plug. Trim the wires flush with enough to reach the outlet on the top of the power box. Lay the wires in the space provided in the plug and close the plug. **Caution before you close, make sure that you do not have any wires crossed as this will create a short.**

Plug in and enjoy light as you quilt.

## Attaching the Belt Guard

The Belt Guard can be found in the box the machine came in. This belt guard covers the motor pulley, hand wheel, and the belt to keep things from getting caught in the belt or damaging the motor sensor disk. The three screws required to attach the belt guard are located in the machine in the holes where the belt guard is positioned.

Step 1. Remove the three (3) screws with washers (A)

Step 2. Place the Belt Guard (B) over the hand wheel and cover the motor pulley

Step 3. Replace the three (3) screws with washers to hold the belt guard in position. Tighten the screw.

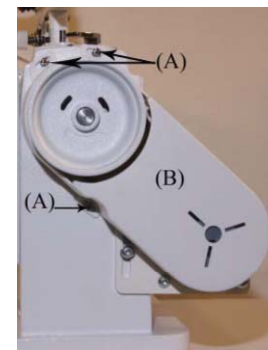
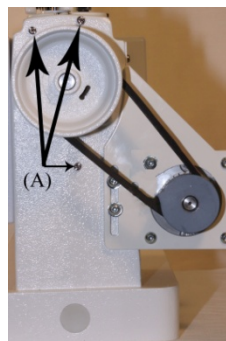

## Your Thread Stand

Your Artistic Quilter SD comes with a four spool thread stand. Some assembly required.

Attach the upper thread support to the cone support base.

1. Place the upper thread support into the hole provided on the base between the cone holders.
2. Use the screw provided to secure the upper thread support into place.

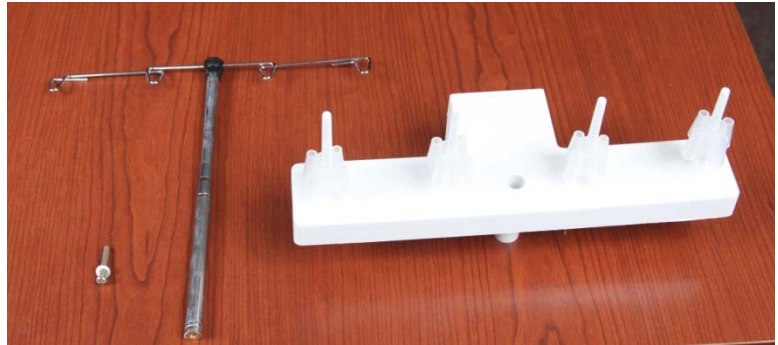

To attach the thread stand on the side of the machine with the motor you will see two screws towards the front of the machine.

1. Loosen the two screws on the side of the machine
2. Slide the thread stand over the two screws
3. Level the thread stand with the top of the machine.
4. Tighten the two screws to hold the thread stand securely in place.



## Control panel

The control panel is the place where you can set speed limit for the Foot Control pedal. You can set the needle position up or down. This is where you connect the foot control pedal and also plug in the power cord and the light cord.

Pressing the F key will change the LED display to either numbers for speed or Letters for UP/Down needle position

Up and down arrows will increase the speed or decrease the speed, 20 is the max speed the machine will run with the foot pedal pushed all the way down. Numbers go from 01 to 20

Up and down arrows will change the needle position to up or down.

Power on/off switch turns power on or off

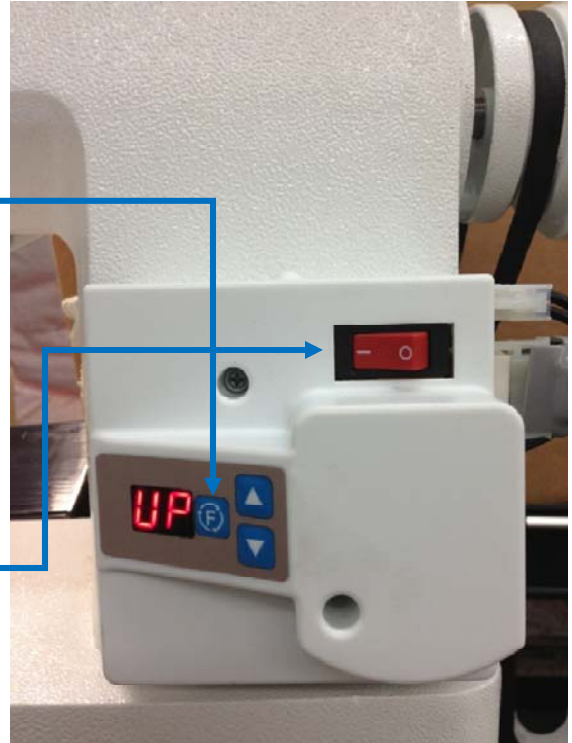

Four port, connector is for the foot control pedal

Three port, connector is for the incoming power cord.

Two port outlet is for Lamp cord.

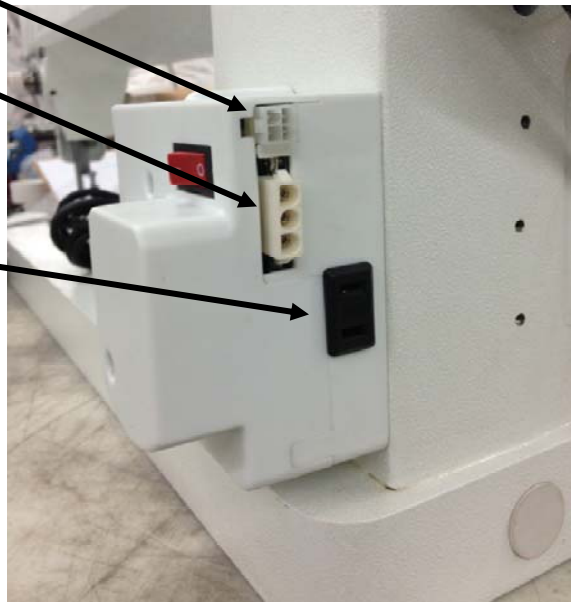

## Needle position

Use the buttons on the control panel to select needle position. If numbers for speed are showing press the F button to switch to the needle positions. Press the up arrow or the down arrow to position the needle.

When you have selected a needle position using the buttons it will stop in that position.

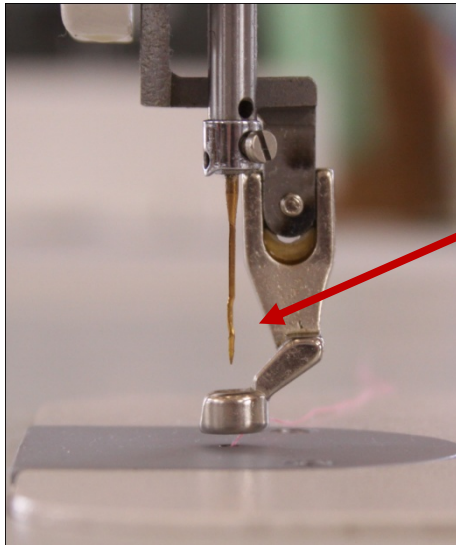

Needle up Position

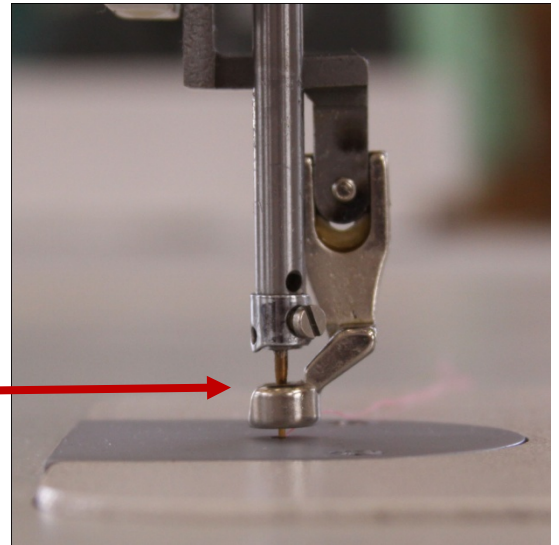

Needle down Position



## Speed settings

You can set the speed settings so that the machine will only go as fast as you have it set when you are pressing the foot pedal all the way down.

If the needle position is showing press the F button to switch to speed. Pressing the up arrow will increase the speed while pressing the down arrow will decrease the speed.

This number is just a reference number. You still control the speed of the machine by how much pressure you put on the foot control pedal.



Minimum Speed



Maximum Speed



## What is the Tension Release Lever?

The tension release lever raises the hopping foot and releases the tension on the thread.

You can watch the tension disc plates open as you lift the lever.

NEVER start sewing with the lever up.

Because there is no tension on the thread the bottom stitches will be huge loops.

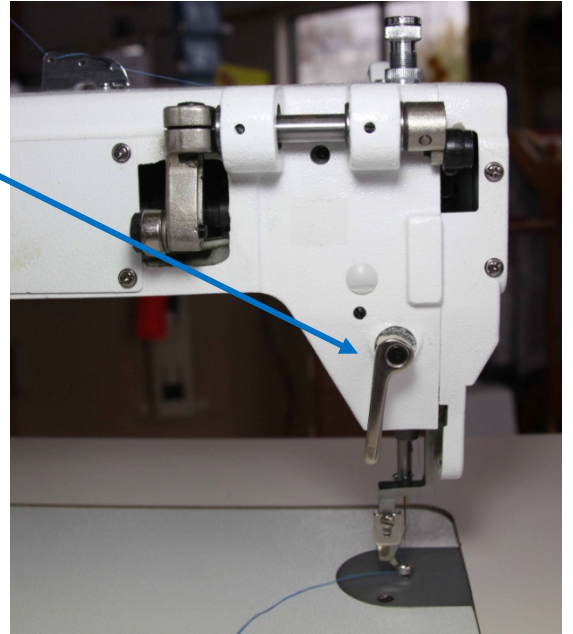

## How Do I Adjust the Height of the Hopping Foot for Thicker or Thinner Batting?

Adjustment screw

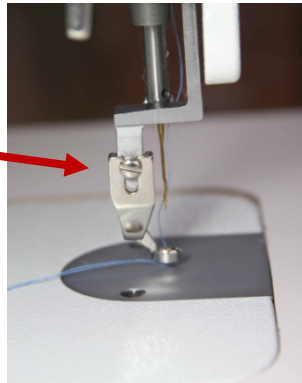

If you are quilting on batting that is thicker than normal you might need to raise the hopping foot. Loosen the screw holding the hopping foot on, slide foot up for thicker down for thinner. Be sure to tighten the screw after your adjustment.

The normal height of the hopping foot should be approximately the height of a dime or three business cards. When the needle is in the down position.

## Routine Cleaning and Oiling

Routine cleaning and oiling is very important to the longevity of your quilting machine. Brush out the fuzz from around the hook and foot. Change your needle regularly to avoid thread breakage, tension problems and needle breakage. A worn needle can mean skipped stitches, shredded thread and a weakening of the needle itself. These things can lead to stitch quality issues.

Lint has a tendency to build up in the bobbin case. A tiny amount of lint can cause poor stitches. Check the bobbin case each time you change the bobbin to keep it clean. We suggest using a soft bristle brush to wipe out the bobbin case and the bobbin area. Canned air only blows the lint around. By using a soft bristle brush you collect the dust on the brush. Occasionally, place a drop of machine oil on a cotton swab to wipe out the bobbin case.

Keep your table clean of dust and oil. Clean the bars and carriage deck regularly for smooth movement.

Oiling is extremely important to the longevity of your quilting machine. Failure to oil your machine regularly can void your warranty.

The one oiling spot marked with red arrow is marked with red paint on your machine. An oil bottle is included with your machine. The one oiling spot marked with a blue arrow contains a dip stick. Remove the dip stick by lifting it up with a finger nail or screw driver. Place drops of oil in this hole.

**Recommended oiling:** After every finished quilt place 3 to 4 drops of oil in the indicated spot. At this time make sure oil is present on dip stick. If not add 3-4 more drops of oil. Run machine to lubricate. For correct oil, when you are out of oil please purchase High Grade Sewing Machine oil. (Note: the machine pictured here is before complete assembly from factory; your machine has more components attached.)

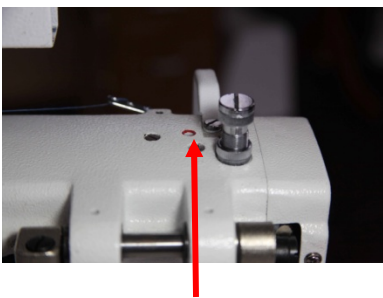

Oil point top of machine

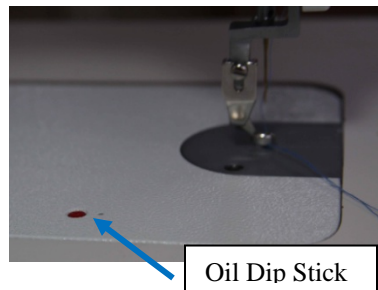

Oil Reservoir with dip stick



Oil Reservoir with dip stick removed

## Bobbin Winder and Bobbins

A bobbin winder is built into your machine. The thread on a properly wound bobbin should be snug and have even layers of thread. A sloppy or mushy wound bobbin will result in poor stitch quality.

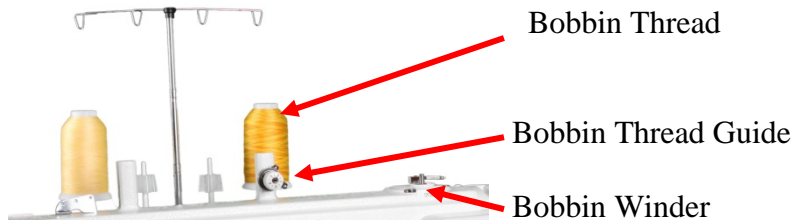

### How do I wind a Bobbin?

1. Insert an empty bobbin on the bobbin winder spindle.
2. Place a cone of thread on the holder.
3. Bring the thread up through the guide over the cone of thread.
4. Insert the thread through the top guide hole then around the tension disk and through the bottom thread guide. This Tension is for the bobbin tension when filling the bobbin.

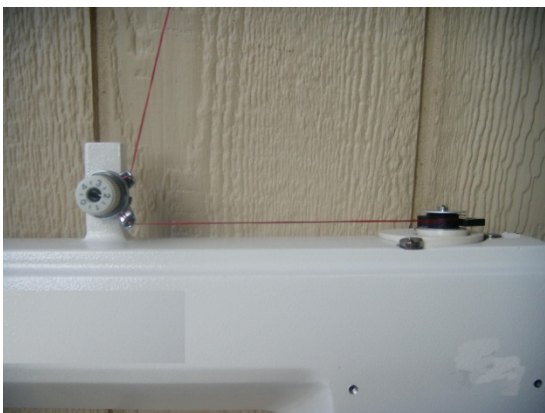
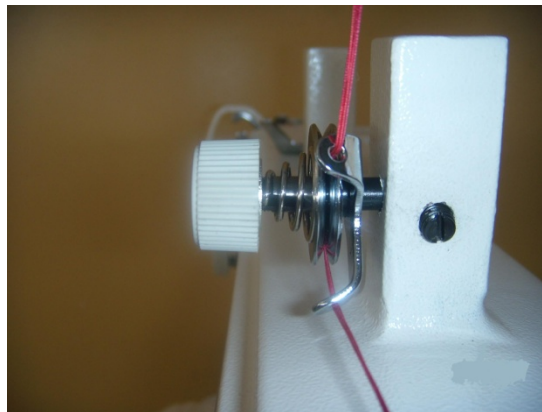
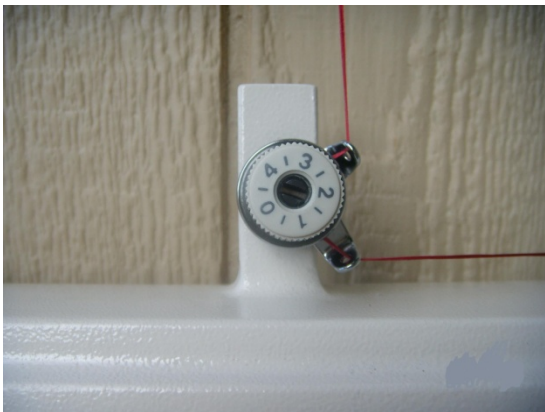



5. Wrap the thread around the bobbin three or four times
6. Push trip mechanism forward until it snaps into position
7. Bobbin winder will start winding the bobbin once you press the foot pedal. You can quilt while your bobbin is winding once it is full it will stop.
8. If you wind your bobbin only (*When not quilting*) ensure that you do not have thread in the needle to prevent jams. Also remove the bobbin and bobbin case to prevent damage.

**NOTE: There is no way to stop the Needle from moving while the bobbin is winding.**

The bobbin will fill until the trip mechanism is pushed out by the thread. It will then disengage the wheel. The bobbin should fill to just below the rim. Having the bobbin too full will cause tension problems.

## Bobbing Fill Mechanism

This picture is provided for your reference should you need to make an adjustment to your bobbin fill mechanism. Never adjust unless you are told to do so by our technicians.

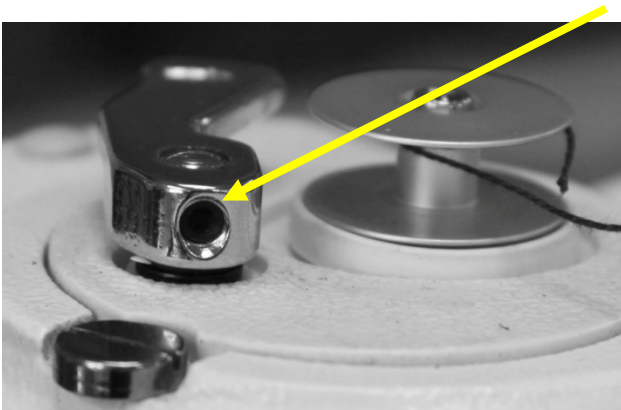

Check the tension of the bobbin by holding the loaded bobbin case in one hand. With one hand under the bobbin case, hold the tail of thread and watch as the thread flows out of the bobbin case. A slight bounce should cause the bobbin case to slide down the thread. If the thread slides out of the case as you pick it up, it needs more tension. If it barely moves down the thread or doesn't move at all, it needs less tension.



Use a small screwdriver to turn the largest set screw on the bobbin case to adjust tension. Make very, very small adjustments. Be very careful not to remove the screw as it is very small and difficult to find if lost. Remember, righty (clockwise) tighty, lefty (counter clockwise) loosey.

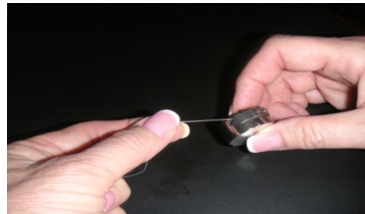

### To place the bobbin into the machine:

1. Insert the bobbin into the bobbin case.
2. Holding the bobbin case pull the thread through the slot.
3. Draw the thread down and under the spring, making sure the thread is in the highest position of the bobbin case.
4. Place the bobbin case in the machine. Always listen for the pop as it engages in the machine.

We suggest using a soft bristle brush to wipe out the bobbin case and the bobbin area. Canned air only blows the lint around. By using the soft bristle brush you collect the dust on the brush.

Each day before you start quilting, unthread your machine past the take up lever and remove the bobbin case, place a small drop of oil in the bobbin hook area before you begin quilting. This will clean out the fuzz and lint. Place a drop of oil in the bobbin hook area. Turn your machine on to run at the slowest setting.

**TIP:** Lint has a tendency to build up in the bobbin case especially with cotton threads. A tiny amount of lint can cause a huge headache! Check the bobbin each time you change it to keep it clean.

## Machine Part Names



( Please note: the takeup lever guard has been removed for a clear view for pictures only. Never run the machine without the guard in place, extreme head injury may occur)

This is a diagram of the side of your long arm machine. The front of the machine faces the belly bar. The back of your machine has the electrical outlet and stitch regulator plugs. The numbers have been assigned in threading order.

- |  |                                    |
|--|------------------------------------|
| 1. Upper Thread Guide<br>(note some machines do not have this) | 7. Take Up Lever                   |
| 2. Three Hole Thread Guide                                     | 8. Thread Guide                    |
| 3. Tension Disc  | 9. Thread Guide                    |
| 4. Check Spring  | 10. Thread Eyelet Above the Needle |
| 5. Silver Angle Bracket  | 11. Needle                         |
| 6. Thread Guide  |                                    |

## Threading Overview



*Please note: the takeup lever guard has been removed for a clear view for pictures only. Never run the machine without the guard in place, extreme head injury may occur.*

## How Do I Thread the Machine?



*Figure 1*

1. Place a cone of thread on the thread holder. *Figure 1*
2. Pull thread through eyelet above the cone of thread. Make sure the eyelet is directly above the thread cone. *Figure 1*

3. Thread in

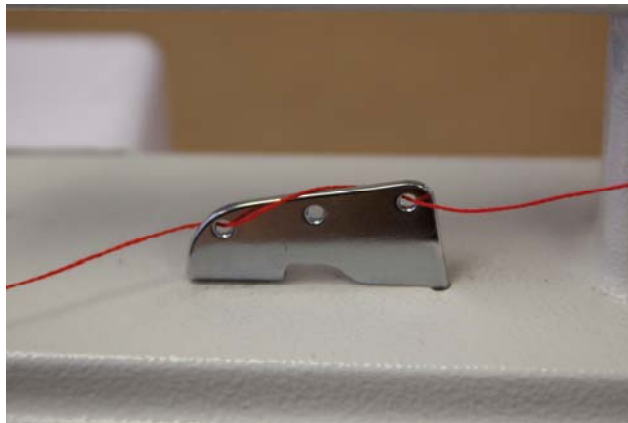

*Figure 2*

upper thread guide as shown picture. *Figure 2*

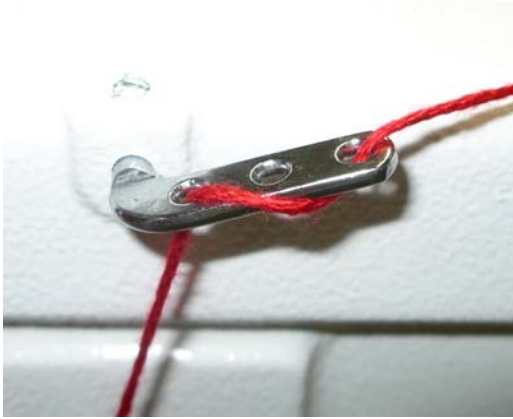

*Figure 3*

4. Weave thread as shown on three hole thread guide.

*Figure 3*



*Figure 4*

5. Take thread between the two tension discs from back to front all the way around. Up and over the check spring. Be sure the thread is going between the discs and go far enough to catch the check spring. The check spring should come down as you pull thread. Pull thread tightly to ensure the thread is in the tension disk. *Figure 4*

6. Thread runs under silver angle bracket. See picture for details. *Figure 4*

7. Bring the thread up through the thread guide just above the check spring. *Figure 4*

8. Take thread through the take up lever from back to front. *Figure 5*

9. Bring the thread down through the two thread guides on the left side.



*Takeup lever guard removed for photos only. Never run the machine without the guard in place, extreme head injury may occur.*

*Figure 5*

**TIP:** Use a dental floss threader to thread the guide directly above the needle. The threader will also thread your needle.

10. Bring the thread through the thread eyelet directly above the needle. *Figure 6*

11. Thread the needle left to right. *Figure 6*



*Figure 6*



## How Do I Change the Needle?

A 134RSAN needle (size 18) will be installed on your Queen Quilter from the factory. When it is time to replace the needle you can easily install one. Be sure the power switch is off on the machine. Remove the bobbin case.

To remove the needle use the smaller screwdriver included with your machine. Loosen the screw just above the thread guide on the needle bar; the needle should fall out as you loosen the screw.

Look closely at the needle. Your home sewing machine needle shank (top of the needle) has a flat side. The top of the long arm machine needle is round. On the point end of the needle there is a scarf, or notch, in one side. **The scarf must face the right of your machine. The long groove at the eye of the needle faces left as you insert the needle.**

### *Why does the scarf go to the right of the machine?*

When the needle goes down through the fabric into the bobbin case, the hook comes around behind the needle to pick up the thread. The scarf has to be there to provide a way for the hook to get between the needle and the thread in order to pick up the thread.

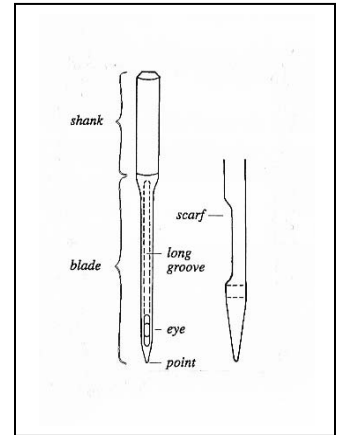

Place the new needle up in the slot, making sure the needle is up in the needle bar as far up as it will go. Make sure the scarf is facing the right of your machine. Tighten the screw on the needle bar while holding the needle up.

***TIP:*** Use the old needle to hold the new needle in place while you tighten the screw. By placing the point of the old needle into the eye of the new needle you can see how straight you are placing the scarf of the needle.

Before you turn your machine on go to the back of the machine and turn the hand wheel a complete turn making sure the needle goes down in the center of the throat plate and the hook in the bobbin area rotates with the needle smoothly. Put the needle down as far as possible. In the bobbin area, you should be able to see you the eye of the needle. When the hook rotates it picks up the thread at the back of the needle then the top thread pulls the bobbin thread up to create a stitch. The scarf must face the right of your machine.

## How Do I Make Adjustments to Make the Perfect Stitch?

Understanding how your long arm machine makes a stitch will help you make the proper adjustments to make the perfect stitch. The technique all long arm machines use to make a stitch is basically opposite of the home sewing machine. The home sewing machine is designed to press together two layers of fabric and sew while the fabric is held in place by the presser foot. Long arm machines are designed to press and sew multiple layers together while the machine head is moving. The difference is that there is practically no needle deflection on a standard sewing machine and a large amount of needle deflection on the long arm. The higher the tension, the more the needle will deflect. Another cause for the needle to deflect on a standard machine is the type of fabric being sewn. A tightly woven fabric tends to force the needle in different directions as it penetrates the fabric. This type of deflection depends greatly on the type of needle and type of point you use, such as a ball point or sharp point.

### **Needle deflection, what is needle deflection? What causes needle deflection? How is needle deflection related to the stitches on my quilt?**

On a long arm quilting machine a stitch is mechanically created the same as a home sewing machine except the quilter is the feed dog moving the machine head over the fabric. The hopping foot presses the fabric together tighter and quicker than a home sewing machine presser foot because the fabric must be able to slide between the foot and the needle plate as the machine is sewing. This means that the machine is moving while the needle is in the fabric. The worst thing for a needle is to be in the fabric while the machine is moving which bends the needle, creating needle deflection.

Good stitches will interlock in the batting between the quilt top and backing. In real life, this goal is rarely achieved. For this reason, you need to be aware that you will have “pokies” if you use different colors of thread on top and in the bobbin. Pokies are where you can see tiny dots of the contrasting thread where the bobbin catches the top thread. If there is slightly more tension on the top than on the bottom, then you will see the pokies on the top side of the quilt. If the greater tension is on the bobbin, then you will see the pokies on the back of the quilt. If the pokies are objectionable to you, use the same color thread on both top and bottom.

**Tip:** *A general rule of thumb is that if the stitch looks bad on the top it is the bottom tension. If the stitch looks bad on the bottom is the upper tension. The upper and lower threads play tug of war with each other.*

**Tension, tension, tension...** This probably causes more problems than anything else. You need correct tension on the top and bottom threads but you also must have correct tension on the quilt held between the bars. You should be able to gently rock the belly bar where the backing fabric is attached. This allows enough movement of your quilt layers for the needle to penetrate and make good stitches.

Before you start making adjustments to your machine ask yourself, “What changed?” If your machine was stitching great and all of a sudden it has loopies on the back or puckers, “What changed?” Did you just change the bobbin? Did you just lift the take up bar? Did you lower the take up bar after finishing your last quilt? Did you recently change the needle? Did you just roll the quilt?

If the take up bar with the quilted portion of your quilt is too high, it will result in poor stitch quality. You need a finger tip space between the quilt and the machine bed. Higher will result in poor stitch quality. Lower and the quilt will create a drag on your machine’s movement.

Look at your bobbin, a sloppy wound bobbin will not create a good stitch. Make sure that the threads on the bobbin are snug and evenly wound. Check to see if there is a piece of lint in the bobbin case.

### **Tension Trouble shooting checklist**

- ◆ Is the side tension lever down?
- ◆ Have I oiled my machine regularly?
- ◆ Is the quilt too tight on the frame?
- ◆ Is the thread coming off the cone freely?
- ◆ Has your thread jumped out of the tension discs?
- ◆ Check your threading. Has anything been missed or has the thread flipped itself around something, increasing your tension?
- ◆ Is the hopping foot too high or too low?
- ◆ Is your take up bar too high? Did you lower the take up bar after your last quilt?
- ◆ Do you need to change your needle?
- ◆ Is your needle in properly?

### **Top Thread Breaking**

- ◆ Check to see that your thread is coming off the spool freely. The thread guide is centered over the spool and has not developed any burrs or catches.
- ◆ Check to see if the thread has looped itself around the spool pin.
- ◆ Check to see if the needle is in correctly, with the scarf facing the back of the machine.
- ◆ Have you recently changed the needle? Is it as high as it will go in the needle bar?

### **Eyelashes**

Eyelashes on the back of the quilt can be caused by too little top tension. Turn the thread tension disk clockwise ¼ turn. Make small adjustments. Repeat until stitch quality is good. Remember the upper and lower thread play tug of war with each other.

### **Loose Top Stitch**

Is the tension lever handle down? It lowers the hopping foot and applies the tension disk.

Is the bobbin thread inserted in the slot of the bobbin case?

Adjust the tension disk small turns clock wise. Repeat until stitch quality if good.

### **Quilt Top Puckers**

Is your backing fabric stretched too tight? While the backing fabric needs to lie flat and without wrinkles, stretching it too tight can make the quilt top pucker. After stitching and releasing the backing fabric the top will pucker.

The top tension is too tight. Adjust the tension disc small turns counter clockwise. Repeat until stitch quality is good.

### **Stitches are Skipped**

Skipped stitches leave needle holes without thread while large and small stitches in regulated mode means the encoders are not picking-up the signal of your movements because of lint or thread stopping or slowing the reading.

First, check to see that your machine is threaded correctly. Look at the check spring, does the thread lay in the check spring? When properly threaded the check spring will move up and down as the machine is stitching and the thread is flowing freely.

Check the needle. Be sure it is all the way up into the shaft and the scarf is toward the back. If it has been used for some time, replace the needle. A blunt needle will make a popping sound as it penetrates the quilt sandwich.

### **Machine Drags Making it Difficult to Move**

Check to make sure the quilt on the take up bar is not dragging on the bed of the machine. A finger tip distance between the take up bar and the bed of the machine is all that is necessary. Elevating the take up bar too high can cause loopies on the back. Look for lint or thread that might be snagging as you move the machine.

### **Difficult to Control the Movement of the Machine**

Check for lint or other debris on the track and bars. Sometimes the smallest pieces of thread create the biggest headaches.

## Check spring replacement/Tension Knob

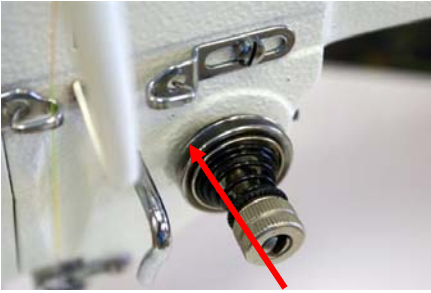

Fig 1: Tension Assembly with broken Spring (old tension knob)



Fig 2: Tension Assembly with good spring (new Tension knob)



Fig 3: Screw on inside of machine loosen only **DO NOT REMOVE**



Fig 4: Remove assembly from machine. Be careful of release pin (see fig 6)



Fig 5: Machine with tension assembly removed



Fig 6: Tension assembly out of machine **DO NOT LOOSE PIN**



Fig 7: Loosen screw only **DO NOT REMOVE**



Fig 8: Remove tension assembly from barrel



Fig 9: Tension assembly, Barrel



Fig 10: Remove spring



Fig 11: Spring removal



Fig 12: Spring removed

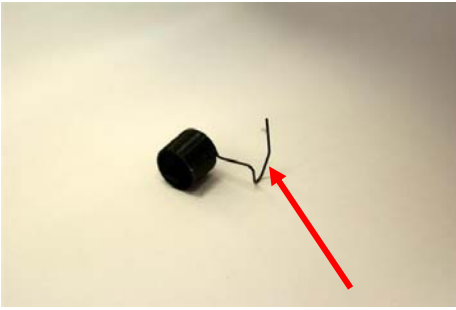

Fig 13: New Spring, This is what was broken



Fig 14: Insert New Spring



Fig 15: Twist while inserting new spring

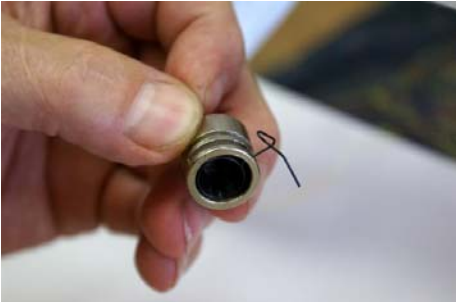

Fig 16: New spring in place



Fig 17: Insert the tension assembly back in barrel



Fig 18: Insure that you are all the way in



Fig 19: give the tension assembly a twist until you feel resistance on the check spring



Fig 20: Tighten screw. Make sure pin is still there



Fig 21: Place the assembly back into your machine



Fig 22: Once in ensure that your check spring is at 11:00 (refer to fig 26 for correct placement)



Fig 23: Press in and notice the tension disk opens



Fig 24: Release and the disk will close; this is the proper place for your tension assembly



Fig 25: Tighten screw on your machine.

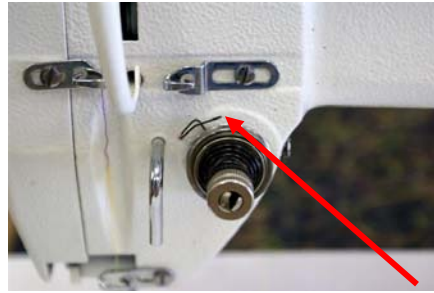

Fig 26: Tension assembly back in place with new check spring at 11:00



Fig 27: For fine adjustment of check spring insert screwdriver turn clockwise for more tension

## Timing between needle and rotating hook



Remove the two needle plate screws from your machine.



You will also need to remove the three Face plate screws

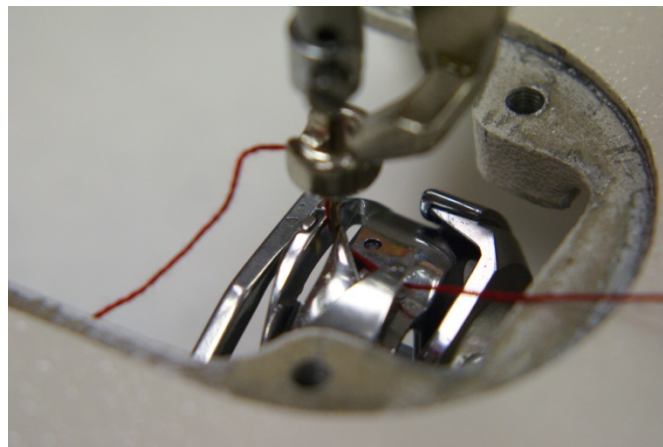
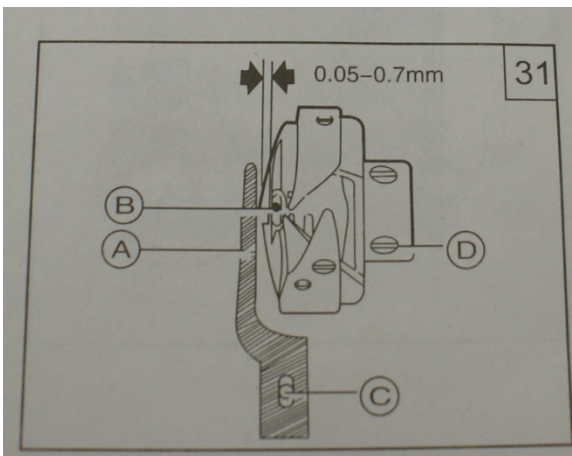

The protecting flange of the position bracket A should be engaged in the notch B of the bobbin case holder. D is set screw to adjust hook timing. (Photo on the right is actual machine as shown in Drawing) Drawing and photo show correct timing.

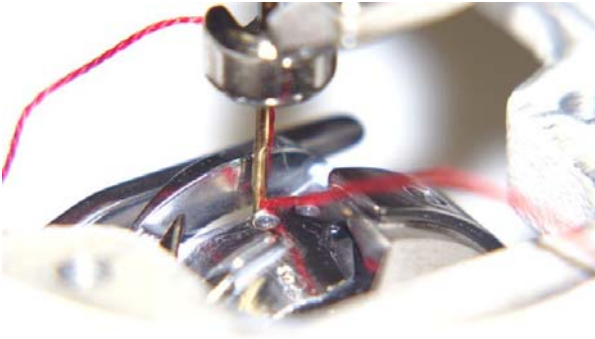

Turn the hand wheel to locate the needle at it's lowest position. Note: correct needle position is when you can see a small portion of the eye of the needle. This picture shows correct location.

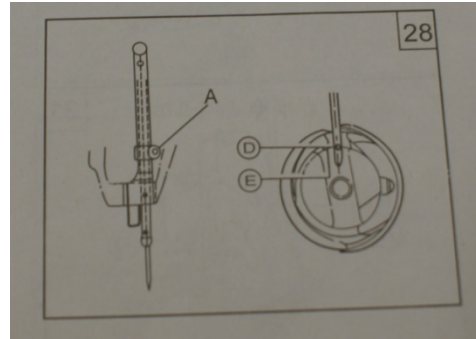

Loosen Needle bar connecting screw A. This will allow you to raise and lower needle bar for correct location. Note: Check all photos before making any adjustments

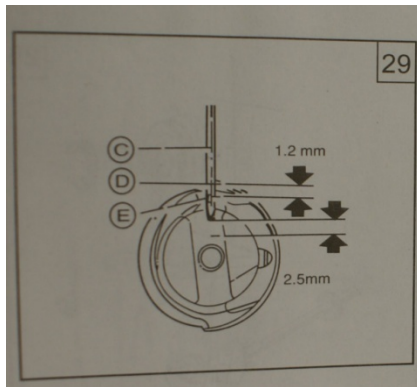

Adjusting rotating hook point timing with needle  
Turn the hand wheel counter clockwise to locate needle to its lowest position. At lowest position turn hand wheel to raise needle 2.5 mm (1/8") Hook point should be just above eye of needle.

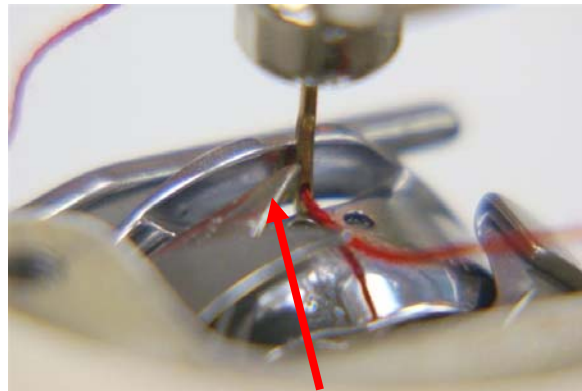

Hook Point

This picture shows needle bar and hook point at the proper location. After needle bar rise. Note if hook point is not in this location reference drawing 31 loosen screw D there are three screws. At this point the rotating hook can be moved freely On its shaft. To locate proper timing.

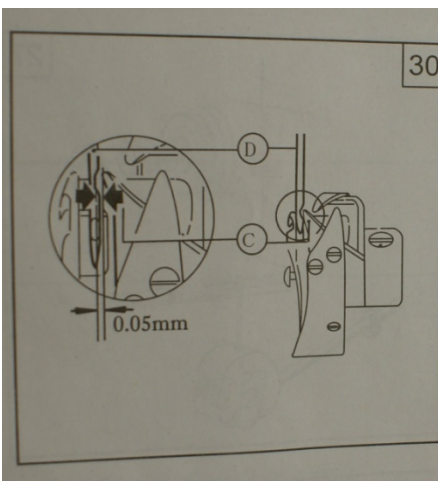

When adjusting the rotating hook point timing also note that clearance between notch bottom of needle D and hook point C must be maintained. Hook cannot rub against needle. Also see drawing 31 for better view



**Notes:**